

MOUNTING INSTRUCTION

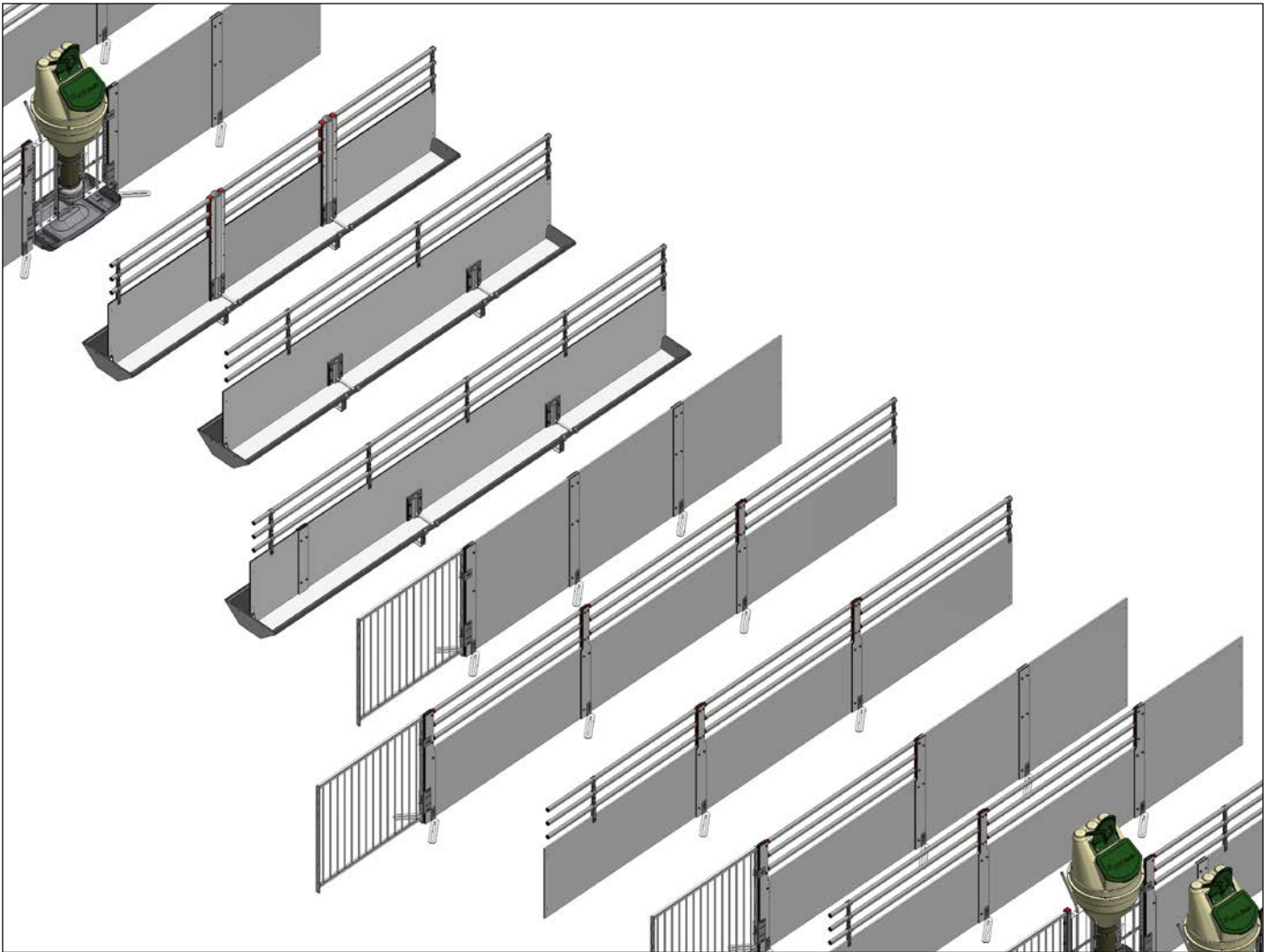

FUNKI FIBER 870 / 995 mm

NOTE! Rules and dimensions are exemplified with illustrations and item numbers for 995 mm. The same rules and dimensions apply to 870 mm.



ACO FUNKI A/S
Kirkevænget 5
DK-7400 Herning

Tel. +45 9711 9600
www.acofunki.com
www.egebjerg.com

FUNKI

Fiber_870_995_01

NOTE:

- Plate length: max 4100 mm
(The plate length should be near 4100 mm to avoid waste)
- Distance between foundation sets: max 1500 mm
(If the distance exceeds 1500 mm, a support foundation is mounted)
- Grille against feeder: see Table 1 below

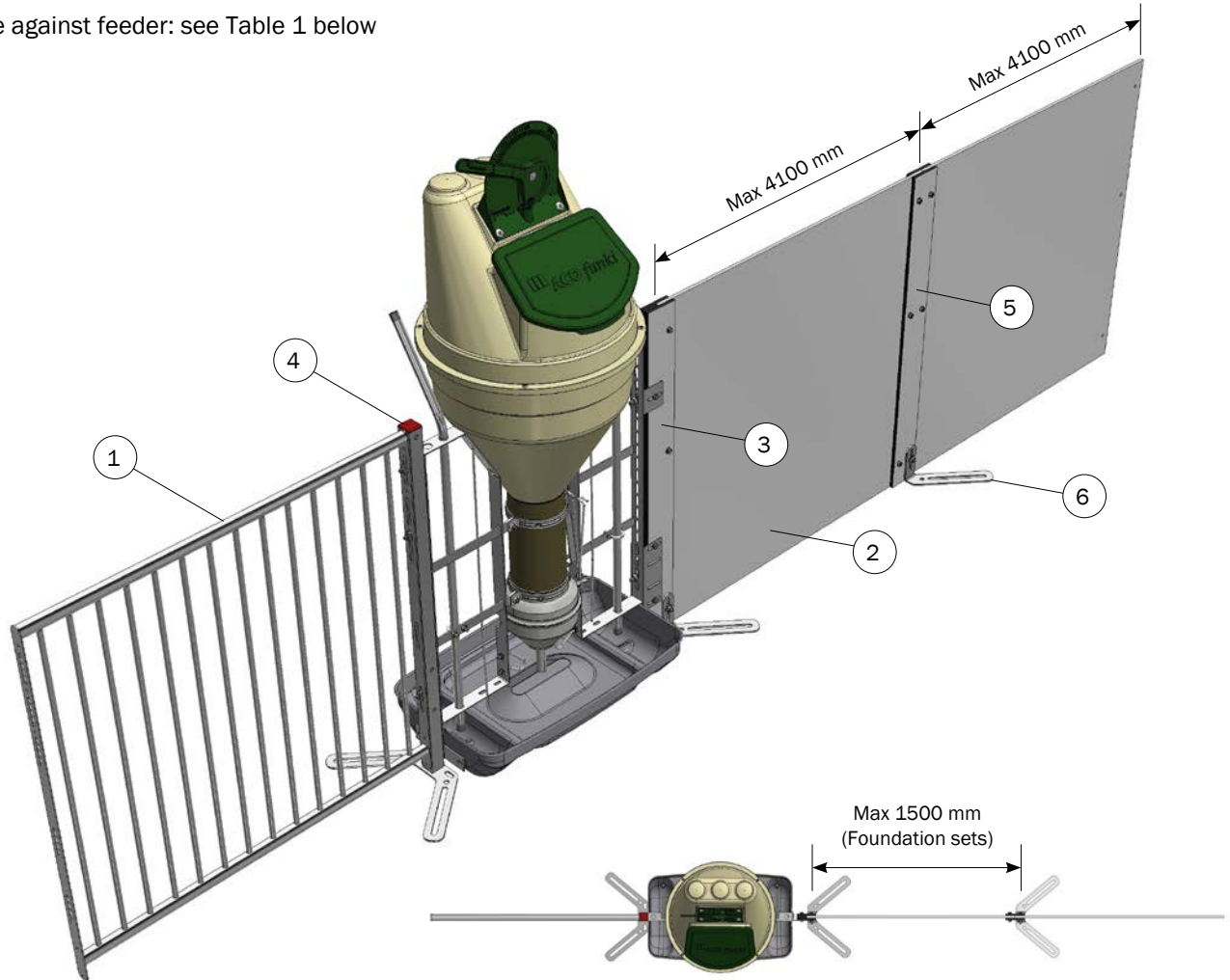

TABLE 1 - GRILLE AGAINST FEEDER

Højde, mm	L = 1040 mm	L = 1260 mm	L = 1540 mm
995	4200104	4200126	4200154
870	4400104	4400126	4400154
745	3200104	3200126	3200154

BILL OF MATERIALS

	Item no.	Description	Pcs.
		<i>FIBER_870_995_01</i>	
1	4200104	GRILLE FOR CLEAN-O-FLEX 1000/1040	1
2	4660475-LENGTH	SIDE H100 PLATE	2
3	4600442	POST H100 PLATE FOR FEEDERS	1
4	38524	MOUNTING KIT FOR U-POST AGAINST FEEDERS	1
5	4600433	ASSEMBLY POST H100	1
6	4500655	LOOSE FOUNDATION SET, LEFT AND RIGHT, FOR BOARD PROFILE	2

Fiber_870_995_02

NOTE:

- Plate length: max 4100 mm
(The plate length should be near 4100 mm to avoid waste)
- Distance between foundation sets: max 1500 mm
(If the distance exceeds 1500 mm, a support foundation is mounted)
- Bar length: max 6000 mm
(Stiffening bracket per max 1400 mm)
- Grille against feeder: see Table 1 below

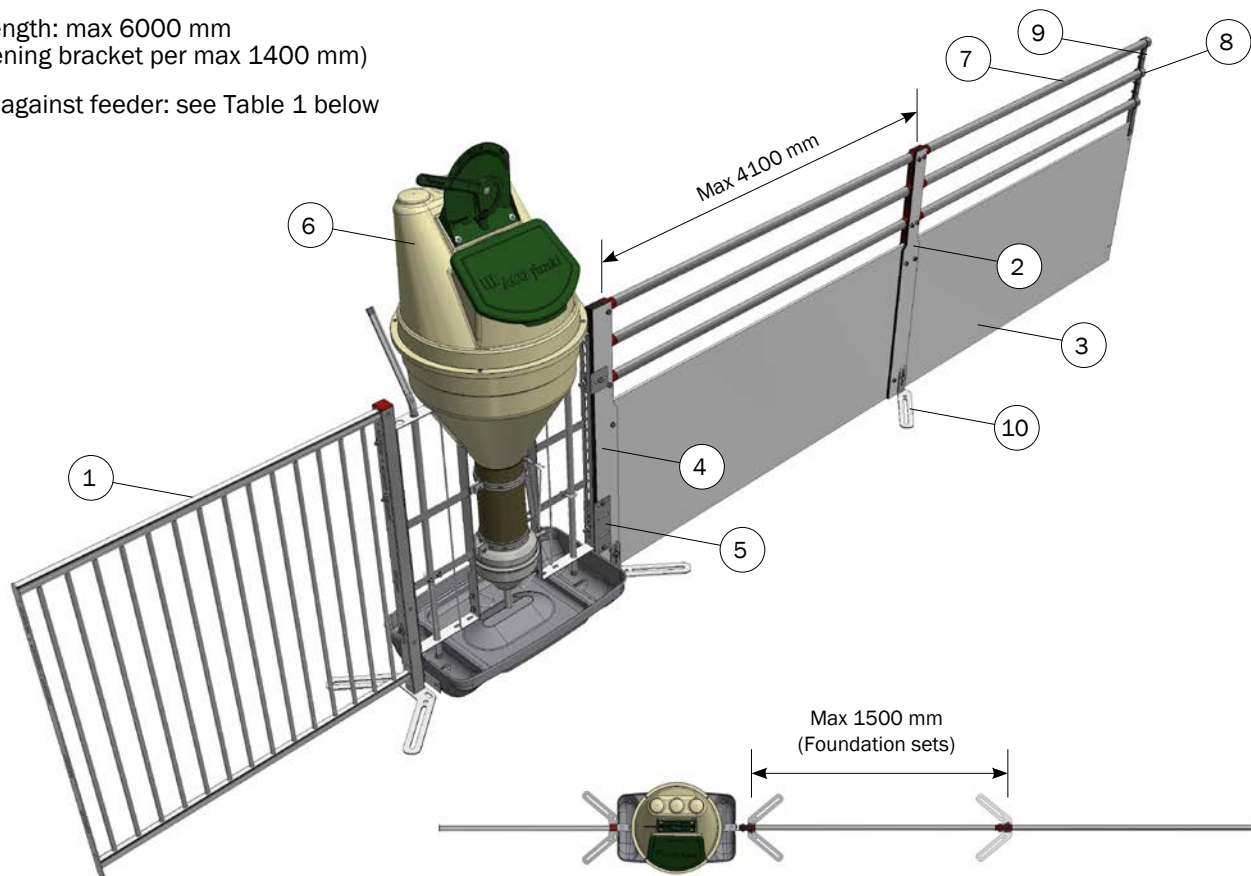

TABLE 1 - GRILLE AGAINST FEEDER

Højde, mm	L = 1040 mm	L = 1260 mm	L = 1540 mm
995	4200104	4200126	4200154
870	4400104	4400126	4400154
745	3200104	3200126	3200154

BILL OF MATERIALS

	Item no.	Description	Pcs.
		<i>FIBER_870_995_02</i>	
1	4200104	GRILLE FOR CLEAN-O-FLEX 1000/1040	1
2	4600438	POST KIT H100 PLATE/3 BARS	1
3	4560647	SIDE H64,2 PLATE MAX. LENGTH 4100 MM	2
4	4600445	POST H100 PLATE FOR 3 BARS/FEEDERS	1
5	38524	MOUNTING KIT FOR U-POST AGAINST FEEDERS	1
6	560710M	FUNKIMAT WEANER WITH STAINLESS STEEL TROUGH (FLAT-FLAT)	1
7	4610410	3 BARS 1' GALVANIZED, PRICE PER METER	2
8	4500653	3 ROUND CAP BLACK (1' PIPE)	1
9	38944	1 PCS. STIFFENING BRACKET SET FOR 3 BARS ON PLATE	1
10	4500655	LOOSE FOUNDATION SET, LEFT AND RIGHT, FOR BOARD PROFILE	2

Fiber_870_995_03

NOTE:

- Plate length: max 4100 mm
(The plate length should be near 4100 mm to avoid waste)
- Distance between foundation sets: max 1500 mm
(If the distance exceeds 1500 mm, a support foundation is mounted)
- Bar length: max 6000 mm
(Stiffening bracket per max 1400 mm)

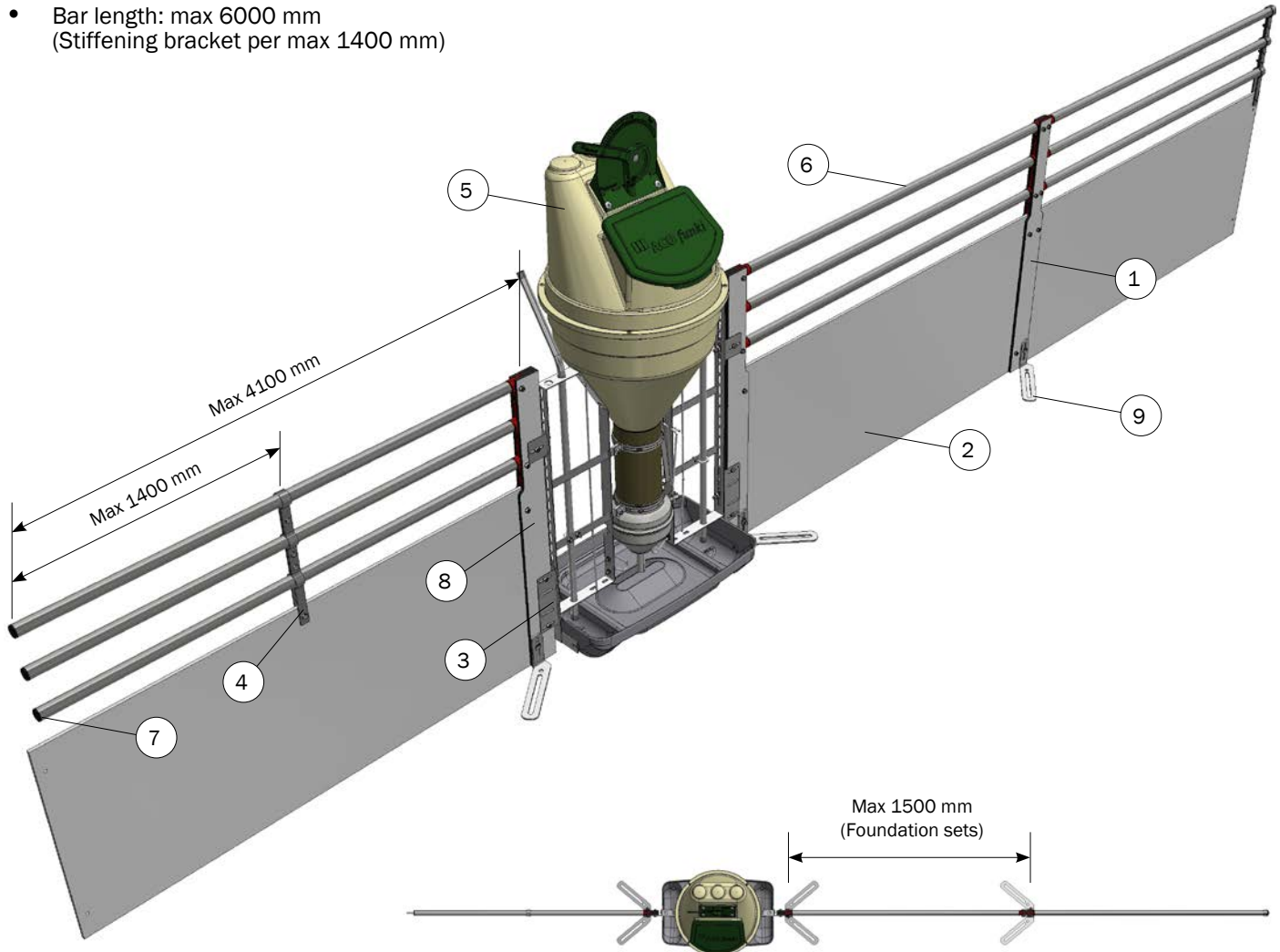

BILL OF MATERIALS

	Item no.	Description	Pcs.
		<i>FIBER_870_995_03</i>	
1	4600438	POST KIT H100 PLATE/3 BARS	1
2	4560647	SIDE H64,2 PLATE MAX. LENGTH 4100 MM	3
3	38524	MOUNTING KIT FOR U-POST AGAINST FEEDERS	2
4	4600482	2 PCS STIFFENING BRACKET SET FOR 3 BARS ON PLATE	1
5	560710M	FUNKIMAT WEANER WITH STAINLESS STEEL TROUGH (FLAT-FLAT)	1
6	4610410	3 BARS 1' GALVANIZED, PRICE PER METER	3
7	4500653	3 ROUND CAP BLACK (1' PIPE)	2
8	4600445	POST H100 PLATE FOR 3 BARS/FEEDERS	2
9	4500655	LOOSE FOUNDATION SET, LEFT AND RIGHT, FOR BOARD PROFILE	3

Fiber_870_995_04

NOTE:

- Plate length: max 4100 mm
(The plate length should be near 4100 mm to avoid waste)
- Distance between foundation sets: max 1500 mm
(If the distance exceeds 1500 mm, a support foundation is mounted)
- Bar length: max 6000 mm
(Stiffening bracket per max 1400 mm)
- Grille against feeder: see Table 1 below

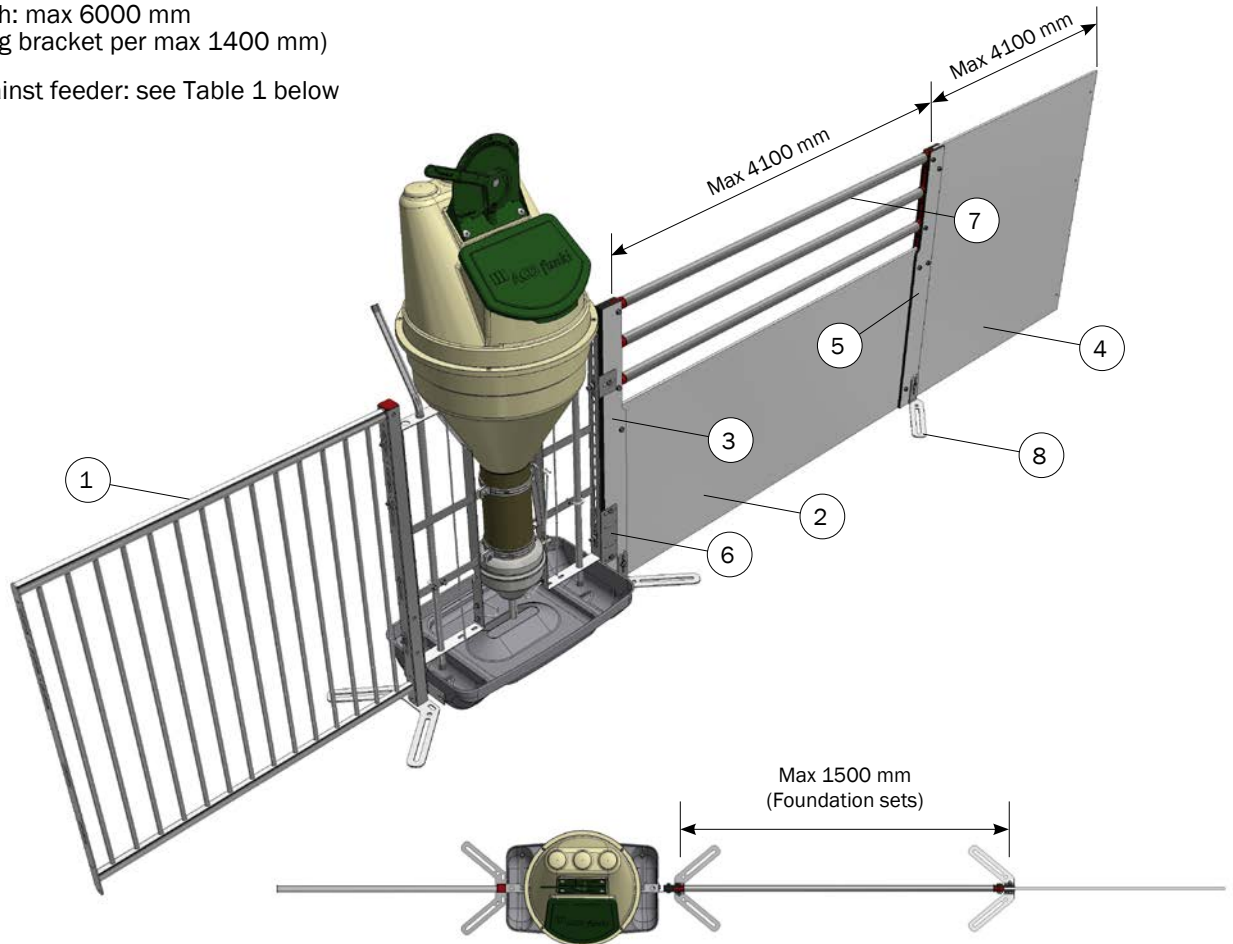

TABLE 1 - GRILLE AGAINST FEEDER

Højde, mm	L = 1040 mm	L = 1260 mm	L = 1540 mm
995	4200104	4200126	4200154
870	4400104	4400126	4400154
745	3200104	3200126	3200154

BILL OF MATERIALS

	Item no.	Description	Pcs.
		<i>FIBER_870_995_04</i>	
1	4200104	GRILLE FOR CLEAN-O-FLEX 1000/1040	1
2	4560647	SIDE H64,2 PLATE MAX. LENGTH 4100 MM	1
3	4600445	POST H100 PLATE FOR 3 BARS/FEEDERS	1
4	4660475	SIDE H100 PLATE	1
5	4600440	POST KIT H100 COMBI PLATE/3 BARS	1
6	38524	MOUNTING KIT FOR U-POST AGAINST FEEDERS	1
7	4610410	3 BARS 1' GALVANIZED, PRICE PER METER	1
8	4500655	LOOSE FOUNDATION SET, LEFT AND RIGHT, FOR BOARD PROFILE	2

Fiber_870_995_05

NOTE:

- Plate length: max 4100 mm
(The plate length should be near 4100 mm to avoid waste)
- Distance between foundation sets: max 1500 mm
(If the distance exceeds 1500 mm, a support foundation is mounted)
- Bar length: max 6000 mm
(Stiffening bracket per max 1400 mm)

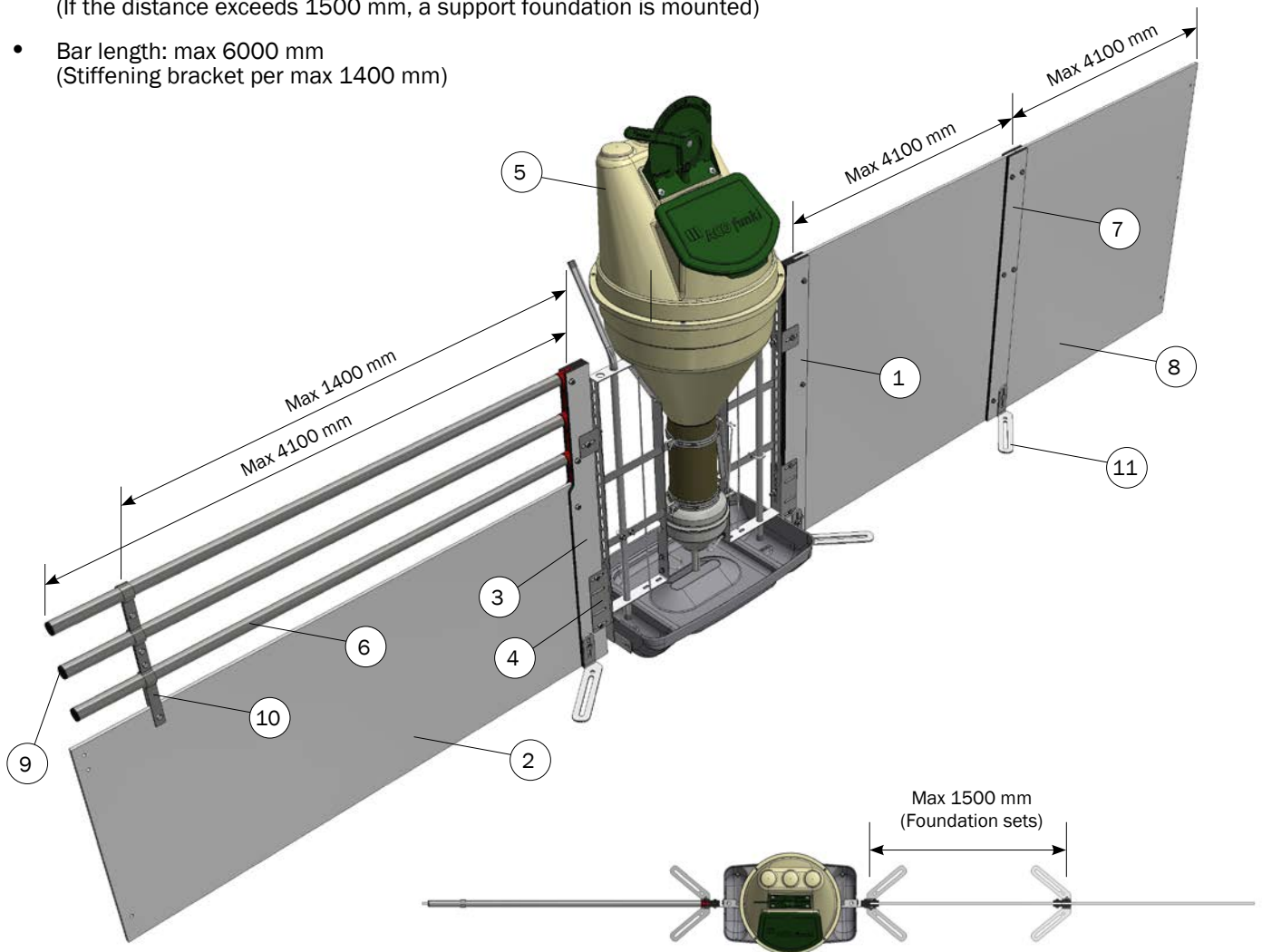

BILL OF MATERIALS			
	Item no.	Description	Pcs.
		<i>FIBER_870_995_05</i>	
1	4600442	POST H100 PLATE FOR FEEDERS	1
2	4560647	SIDE H64,2 PLATE MAX. LENGTH 4100 MM	1
3	4600445	POST H100 PLATE FOR 3 BARS/FEEDERS	1
4	38524	MOUNTING KIT FOR U-POST AGAINST FEEDERS	2
5	560710M	FUNKIMAT WEANER WITH STAINLESS STEEL TROUGH (FLAT-FLAT)	1
6	4610410	3 BARS 1' GALVANIZED, PRICE PER METER	1
7	4600433	ASSEMBLY POST H100	1
8	4660475	SIDE H100 PLATE	2
9	4500653	3 ROUND CAP BLACK (1' PIPE)	1
10	38944	1 PCS. STIFFENING BRACKET SET FOR 3 BARS ON PLATE	1
11	4500655	LOOSE FOUNDATION SET, LEFT AND RIGHT, FOR BOARD PROFILE	3

Fiber_870_995_06

NOTE:

- Plate length, plate with integrated downpipe: max 2000 mm
- Bar length: max 6000 mm
(Stiffening bracket per max 1400 mm)
- Distance between foot bracket sets for trough: max 2000 mm

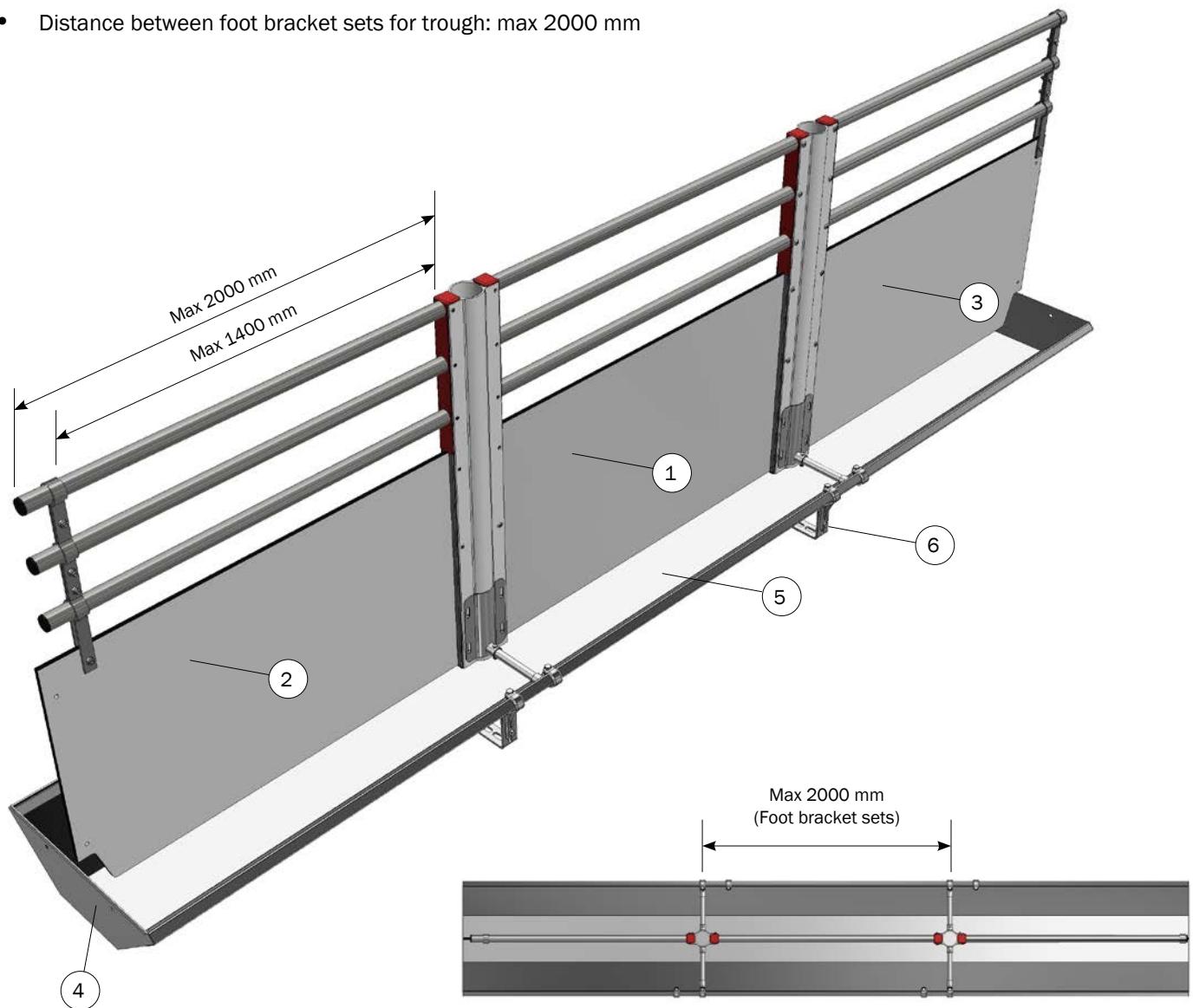

BILL OF MATERIALS			
	Item no.	Description	Pcs.
		<i>FIBER_870_995_06</i>	
1	4610463	LIQUID FEED WALL H100 PLATE/3 BARS, CENTER PIECE	1
2	4610462	LIQUID FEEDING WALL H100 PLATE/3 BARS AGAINST FRONT, DOWNPIPE	1
3	4610461	LIQUID FEEDING WALL H100 PLATE/3 BARS AGAINST WAND, DOWNPIPE	1
4	H5752R	END PIECE LIQUID FEED TROUGH 750 MM	1
5	39234	LIQUID FEEDING TROUGH, DOUBLE, FINISHERS	1
6	31000	FOOT BRACKET SET FOR DOUBLE TROUGH, FINISHERS	1

Fiber_870_995_07

NOTE:

- Plate length: max 4100 mm
(The plate length should be near 4100 mm to avoid waste)
- Bar length: max 6000 mm
(Stiffening bracket per max 1400 mm)
- Distance between foot bracket sets for trough: max 2000 mm

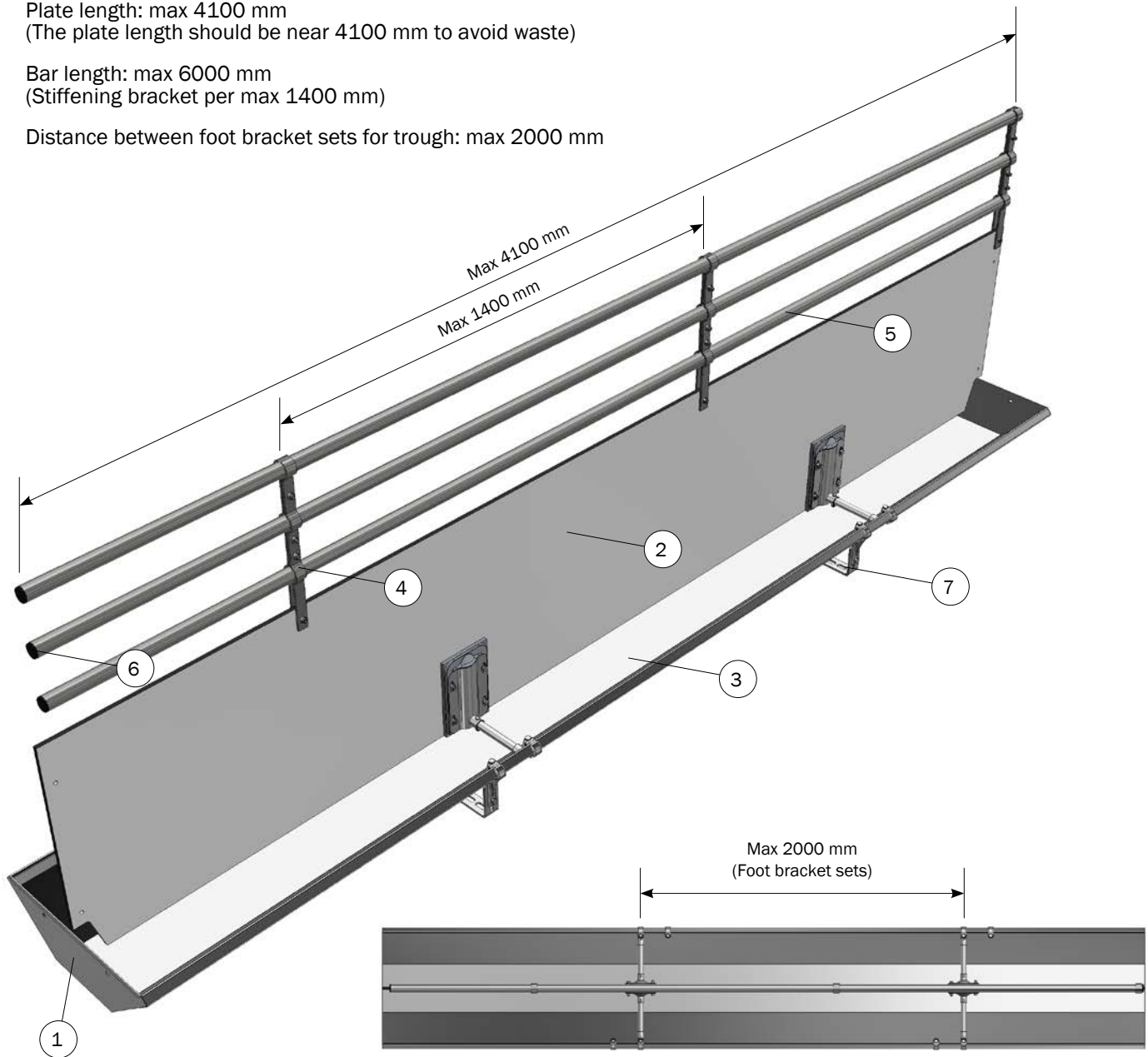

BILL OF MATERIALS			
	Item no.	Description	Pcs.
		<i>FIBER_870_995_07</i>	
1	H5752R	END PIECE LIQUID FEED TROUGH 750 MM	1
2	4560639	PLATE H57 FOR LIQUID FEEDING WALL WITHOUT DOWNPIPE MAX. LENGTH 4100 MM	1
3	39234	LIQUID FEEDING TROUGH, DOUBLE, FINISHERS	1
4	4600483	3 PCS STIFFENING BRACKET SET FOR 3 BARS ON PLATE	1
5	4610410	3 BARS 1' GALVANIZED, PRICE PER METER	1
6	4500653	3 ROUND CAP BLACK (1' PIPE)	2
7	4500663	FOOT BRACKET SET FOR DOUBLE TROUGH, PLATE WEANER	1

Fiber_870_995_08

NOTE:

- Plate length: max 4100 mm
(The plate length should be near 4100 mm to avoid waste)
- Bar length: max 6000 mm
(Stiffening bracket per max 1400 mm)
- Distance between foot bracket sets for trough: max 2000 mm

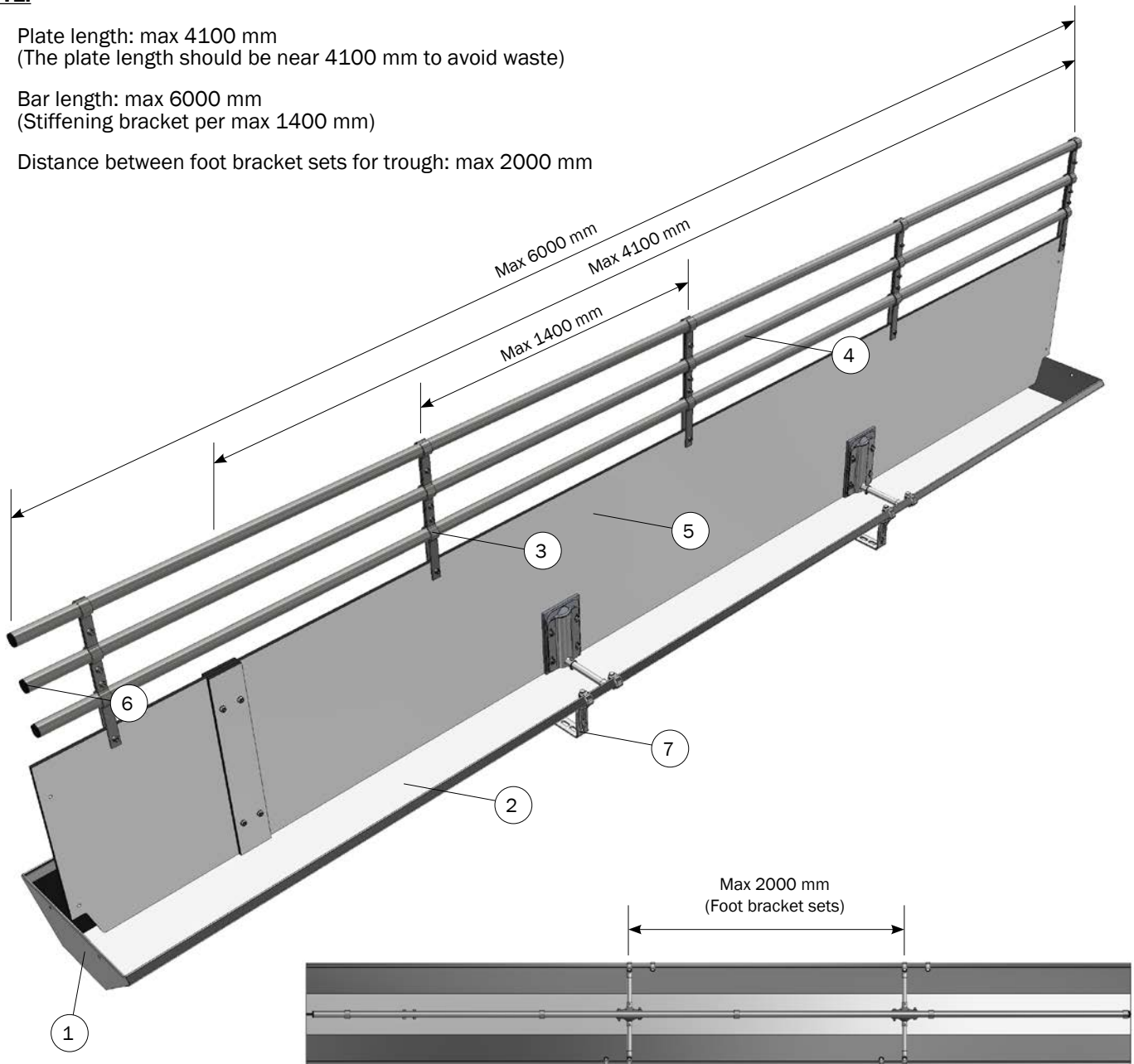

BILL OF MATERIALS			
	Item no.	Description	Pcs.
		<i>FIBER_870_995_08</i>	
1	H5752R	END PIECE LIQUID FEED TROUGH 750 MM	2
2	39234	LIQUID FEEDING TROUGH, DOUBLE, FINISHERS	1
3	4600485	5 PCS STIFFENING BRACKET SET FOR 3 BARS ON PLATE	1
4	4610410	3 BARS 1' GALVANIZED, PRICE PER METER	1
5	4510640	PLATE H57 FOR LIQUID FEEDING WALL WITHOUT DOWNPIPE, LENGHT 4100-6000 MM	1
6	4500653	3 ROUND CAP BLACK (1' PIPE)	2
7	4500663	FOOT BRACKET SET FOR DOUBLE TROUGH, PLATE WEANER	1

Fiber_870_995_09

NOTE:

- Plate length: max 4100 mm
(The plate length should be near 4100 mm to avoid waste)
- Distance between foundation sets: max 1500 mm
(If the distance exceeds 1500 mm, a support foundation is mounted)
- Grille against plate: see Table 2 below

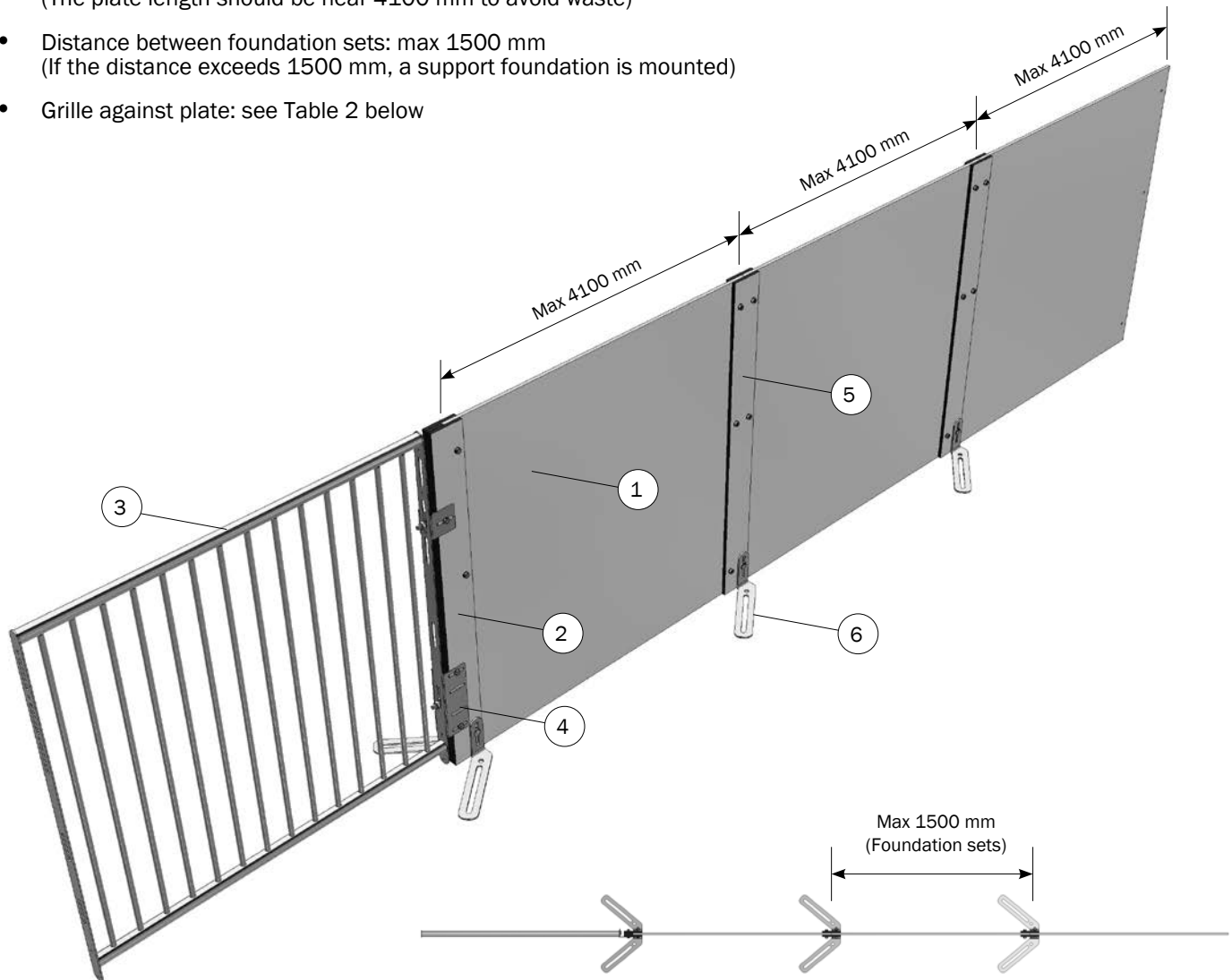

TABLE 2 - GRILLE AGAINST PLATE

Højde, mm	L = 1040 mm	L = 1260 mm	L = 1540 mm
995	4150873	4150874	4150875
870	4450873	4450874	4450875
745	3150873	3150874	3150875

BILL OF MATERIALS

	Item no.	Description	Pcs.
		<i>FIBER_870_995_09</i>	
1	4660475	SIDE H100 PLATE	3
2	4600442	POST H100 PLATE FOR FEEDERS	1
3	4150873	STAINLESS STEEL CONTACT GRILLE H:1000 L:1000	1
4	38524	MOUNTING KIT FOR U-POST AGAINST FEEDERS	1
5	4600433	ASSEMBLY POST H100	2
6	4500655	LOOSE FOUNDATION SET, LEFT AND RIGHT, FOR BOARD PROFILE	3

Fiber_870_995_10

NOTE:

- Plate length: max 4100 mm
(The plate length should be near 4100 mm to avoid waste)
- Bar length: max 6000 mm
(Stiffening bracket per max 1400 mm)
- Distance between foundation sets: max 1500 mm
(If the distance exceeds 1500 mm, a support foundation is mounted)
- Grille against plate: see Table 2 below

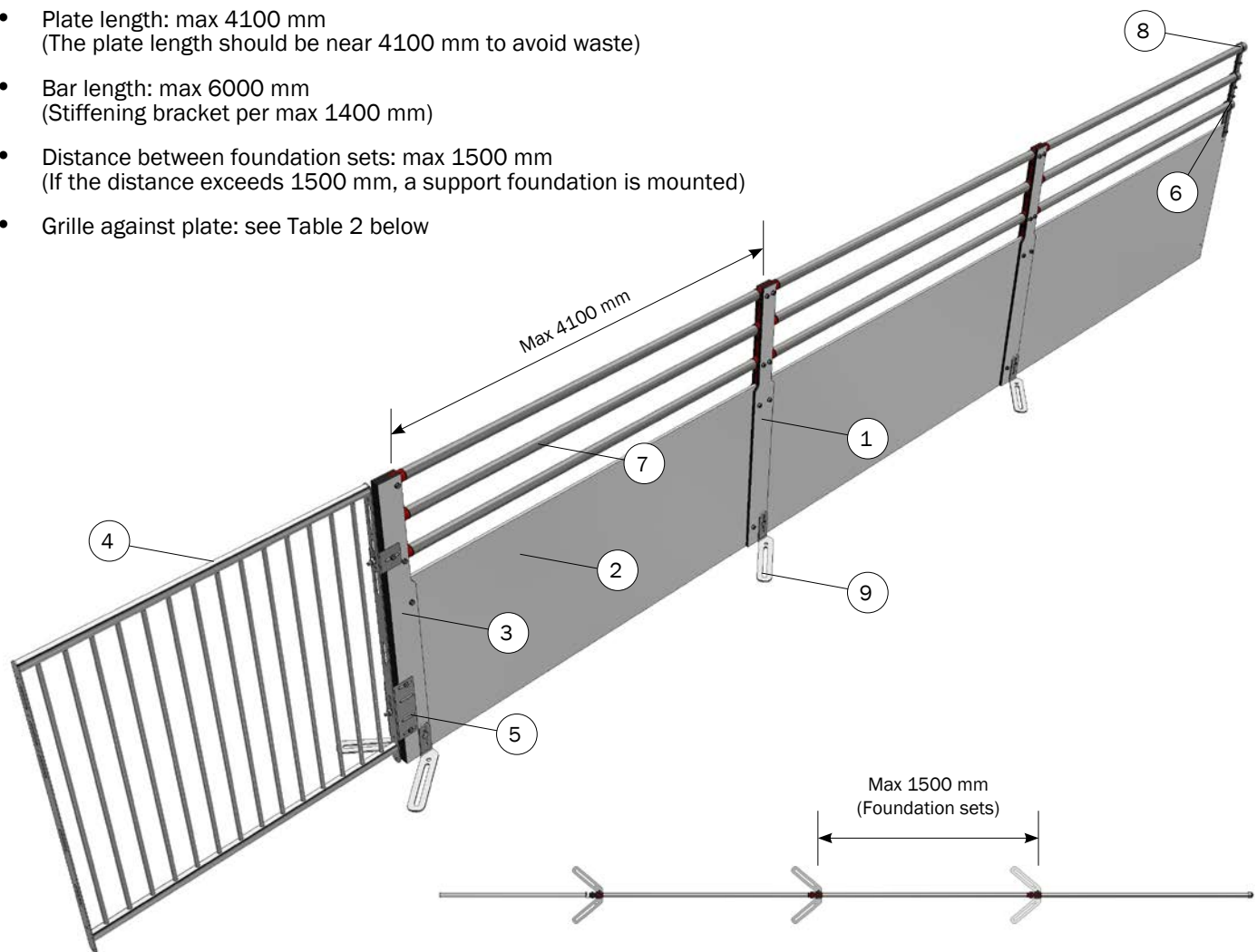

TABLE 2 - GRILLE AGAINST PLATE

Højde, mm	L = 1040 mm	L = 1260 mm	L = 1540 mm
995	4150873	4150874	4150875
870	4450873	4450874	4450875
745	3150873	3150874	3150875

BILL OF MATERIALS

	Item no.	Description	Pcs.
		<i>FIBER_870_995_10</i>	
1	4600438	POST KIT H100 PLATE/3 BARS	2
2	4560647	SIDE H64,2 PLATE MAX. LENGTH 4100 MM	3
3	4600445	POST H100 PLATE FOR 3 BARS/FEEDERS	1
4	4150873	STAINLESS STEEL CONTACT GRILLE H:1000 L:1000	1
5	38524	MOUNTING KIT FOR U-POST AGAINST FEEDERS	1
6	38944	1 PCS. STIFFENING BRACKET SET FOR 3 BARS ON PLATE	1
7	4610410	3 BARS 1' GALVANIZED, PRICE PER METER	3
8	4500653	3 ROUND CAP BLACK (1' PIPE)	1
9	4500655	LOOSE FOUNDATION SET, LEFT AND RIGHT, FOR BOARD PROFILE	3

Fiber_870_995_11

NOTE:

- Plate length: max 4100 mm
(The plate length should be near 4100 mm to avoid waste)
- Bar length: max 6000 mm
(Stiffening bracket per max 1400 mm)
- Distance between foundation sets: max 1500 mm
(If the distance exceeds 1500 mm, a support foundation is mounted)

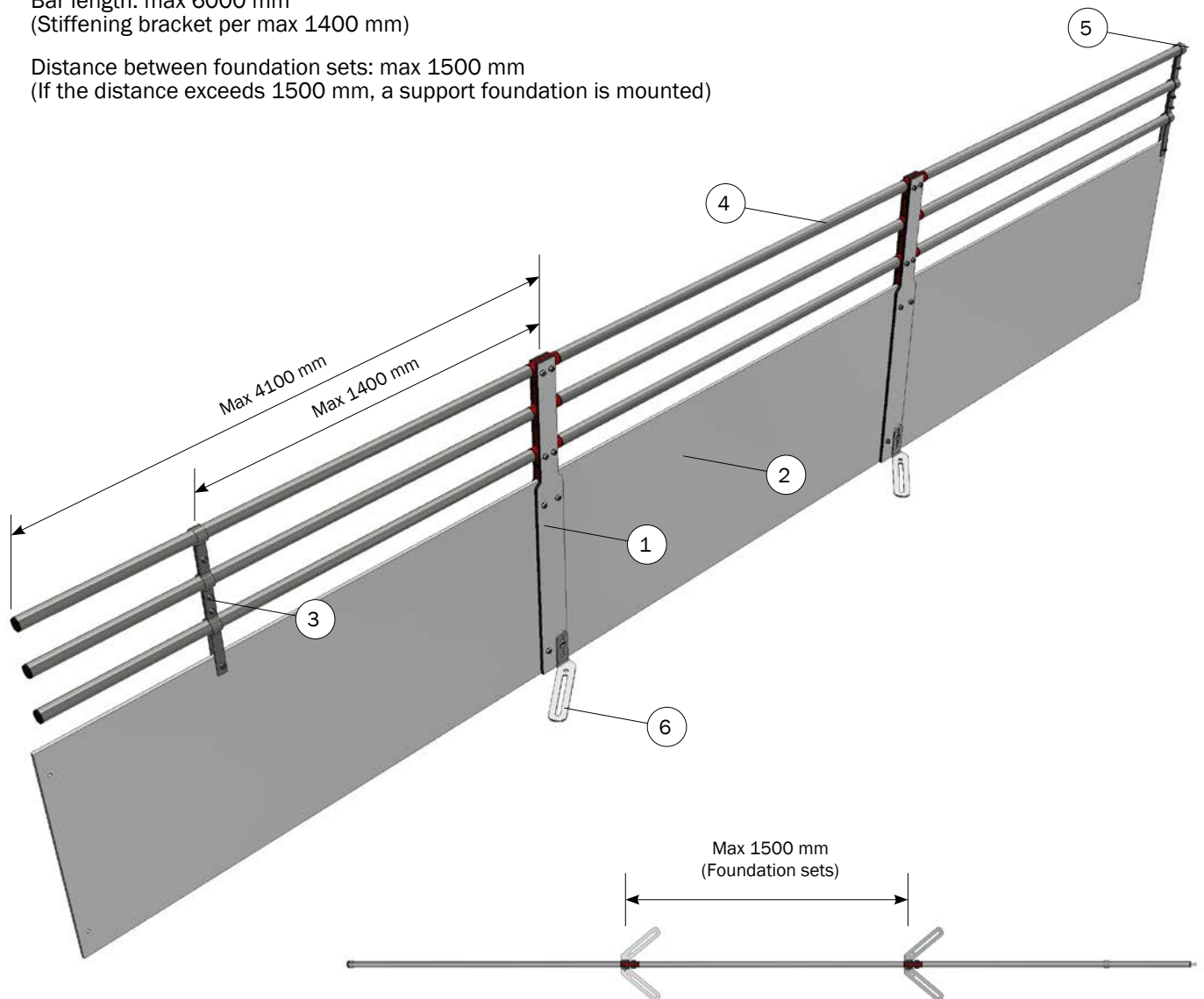

BILL OF MATERIALS			
	Item no.	Description	Pcs.
		<i>FIBER_870_995_11</i>	
1	4600438	POST KIT H100 PLATE/3 BARS	2
2	4560647	SIDE H64,2 PLATE MAX. LENGTH 4100 MM	3
3	4600482	2 PCS STIFFENING BRACKET SET FOR 3 BARS ON PLATE	1
4	4610410	3 BARS 1' GALVANIZED, PRICE PER METER	3
5	4500653	3 ROUND CAP BLACK (1' PIPE)	2
6	4500655	LOOSE FOUNDATION SET, LEFT AND RIGHT, FOR BOARD PROFILE	2

Fiber_870_995_12

NOTE:

- Plate length: max 4100 mm
(The plate length should be near 4100 mm to avoid waste)
- Bar length: max 6000 mm
(Stiffening bracket per max 1400 mm)
- Distance between foundation sets: max 1500 mm
(If the distance exceeds 1500 mm, a support foundation is mounted)
- Grille against plate: see Table 2 below

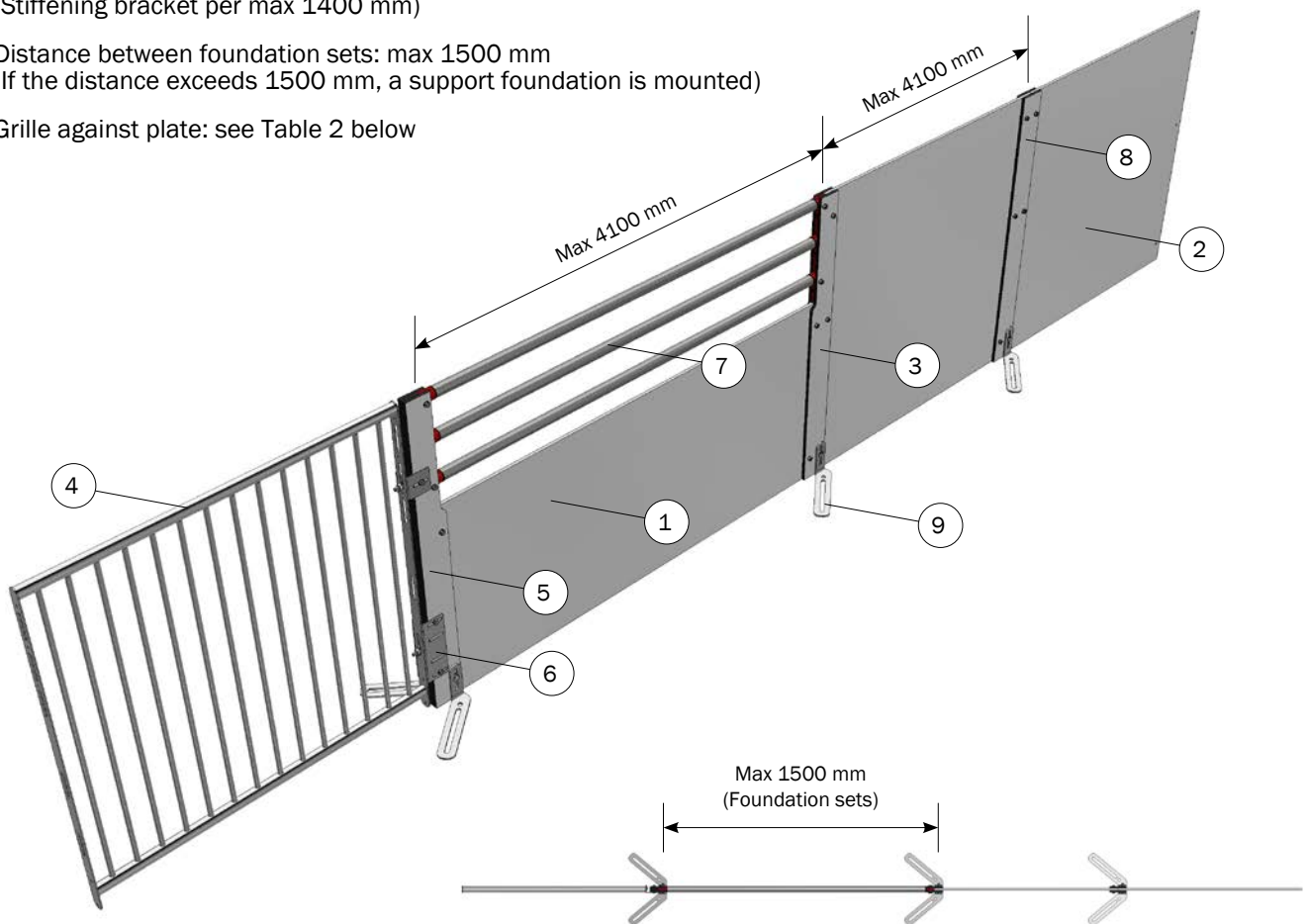

TABLE 2 - GRILLE AGAINST PLATE

Højde, mm	L = 1040 mm	L = 1260 mm	L = 1540 mm
995	4150873	4150874	4150875
870	4450873	4450874	4450875
745	3150873	3150874	3150875

BILL OF MATERIALS

	Item no.	Description	Pcs.
		<i>FIBER_870_995_12</i>	
1	4560647	SIDE H64,2 PLATE MAX. LENGTH 4100 MM	1
2	4660475	SIDE H100 PLATE	2
3	4600440	POST KIT H100 COMBI PLATE/3 BARS	1
4	4150873	STAINLESS STEEL CONTACT GRILLE H:1000 L:1000	1
5	4600445	POST H100 PLATE FOR 3 BARS/FEEDERS	1
6	38524	MOUNTING KIT FOR U-POST AGAINST FEEDERS	1
7	4610410	3 BARS 1' GALVANIZED, PRICE PER METER	1
8	4600433	ASSEMBLY POST H100	1
9	4500655	LOOSE FOUNDATION SET, LEFT AND RIGHT, FOR BOARD PROFILE	3

Fiber_870_995_13

NOTE:

- Plate length: max 4100 mm
(The plate length should be near 4100 mm to avoid waste)
- Bar length: max 6000 mm
(Stiffening bracket per max 1400 mm)
- Distance between foundation sets: max 1500 mm
(If the distance exceeds 1500 mm, a support foundation is mounted)

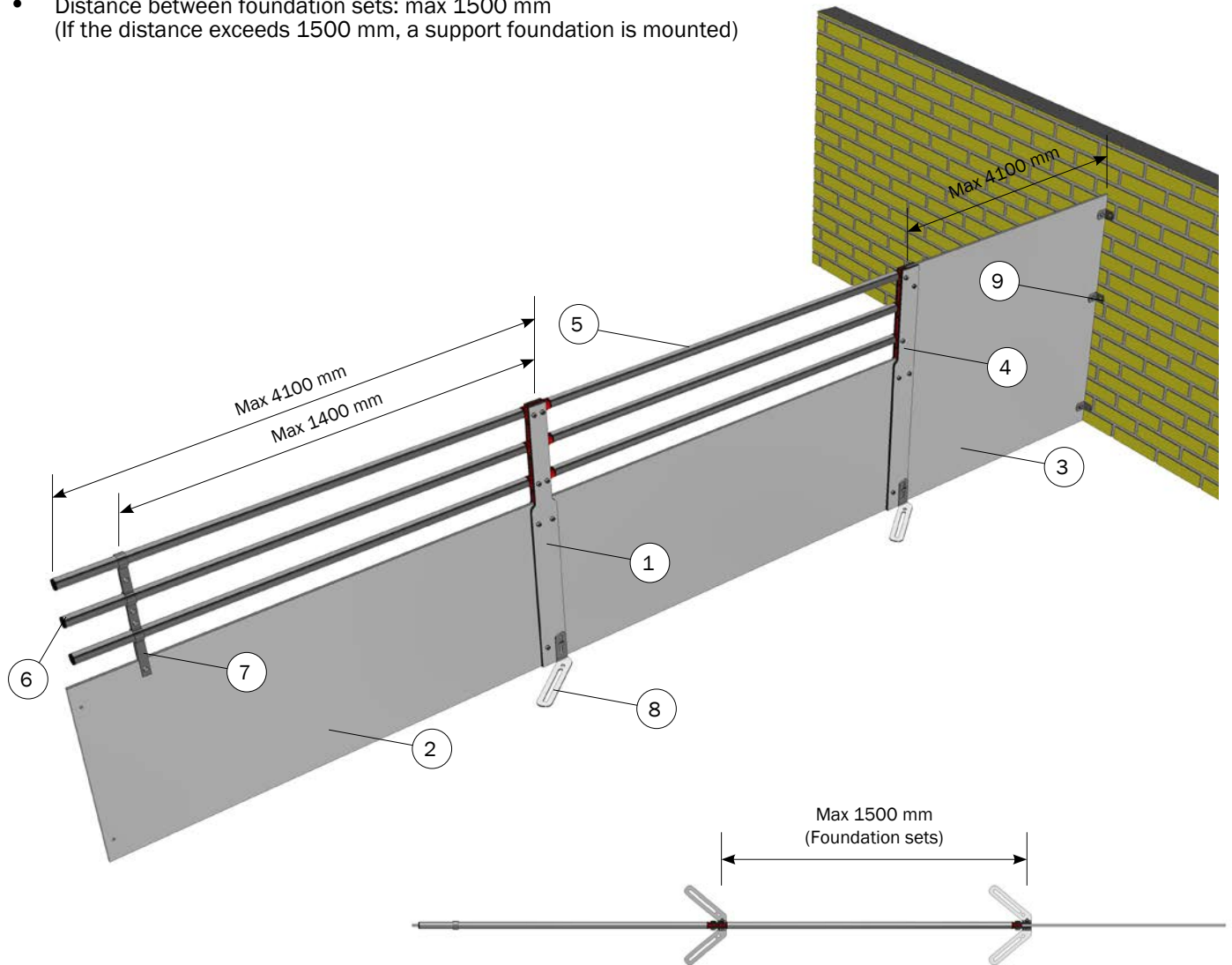

BILL OF MATERIALS

	Item no.	Description	Pcs.
		<i>FIBER_870_995_13</i>	
1	4600438	POST KIT H100 PLATE/3 BARS	1
2	4560647	SIDE H64,2 PLATE MAX. LENGTH 4100 MM	2
3	4660475	SIDE H100 PLATE	1
4	4600440	POST KIT H100 COMBI PLATE/3 BARS	1
5	4610410	3 BARS 1' GALVANIZED, PRICE PER METER	2
6	4500653	3 ROUND CAP BLACK (1' PIPE)	1
7	38944	1 PCS. STIFFENING BRACKET SET FOR 3 BARS ON PLATE	1
8	4500655	LOOSE FOUNDATION SET, LEFT AND RIGHT, FOR BOARD PROFILE	2
9	4500662	MOUNTING KIT FOR PARTITION AGAINST FRONT PART/WASHING WALL	1

Fiber_870_995_14

NOTE:

- Plate length: max 4100 mm
(The plate length should be near 4100 mm to avoid waste)
- Bar length: max 6000 mm
(Stiffening bracket per max 1400 mm)
- Distance between foundation sets: max 1500 mm
(If the distance exceeds 1500 mm, a support foundation is mounted)
- Grille against feeder: see Table 1 below

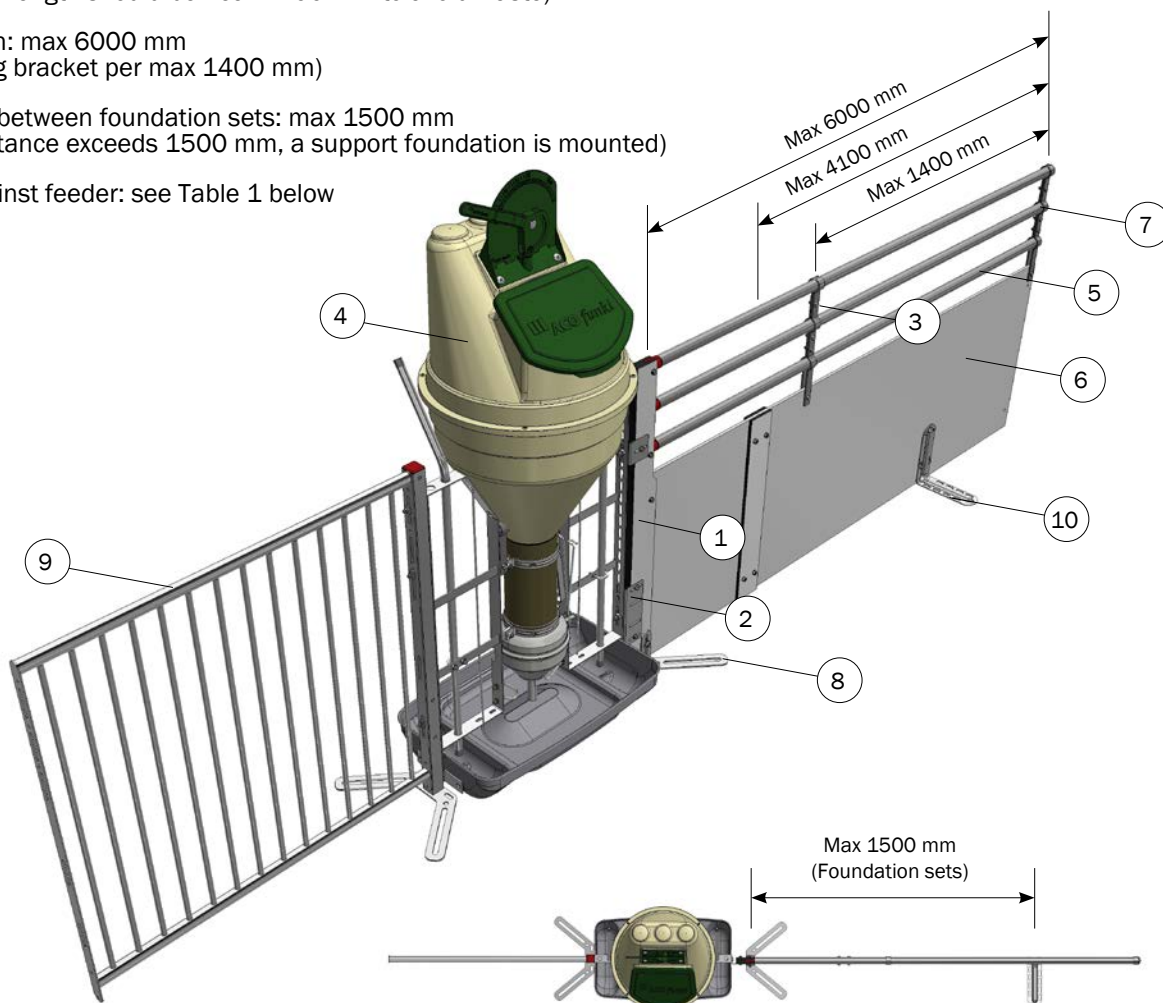

TABLE 1 - GRILLE AGAINST FEEDER

Højde, mm	L = 1040 mm	L = 1260 mm	L = 1540 mm
995	4200104	4200126	4200154
870	4400104	4400126	4400154
745	3200104	3200126	3200154

BILL OF MATERIALS

	Item no.	Description	Pcs.
		<i>FIBER_870_995_14</i>	
1	4600445	POST H100 PLATE FOR 3 BARS/FEEDERS	1
2	38524	MOUNTING KIT FOR U-POST AGAINST FEEDERS	1
3	4600483	3 PCS STIFFENING BRACKET SET FOR 3 BARS ON PLATE	1
4	560710M	FUNKIMAT WEANER WITH STAINLESS STEEL TROUGH (FLAT-FLAT)	1
5	4610410	3 BARS 1' GALVANIZED, PRICE PER METER	1
6	4510648	SIDE H64,2 PLATE LENGTH 4100-6000 MM	1
7	4500653	3 ROUND CAP BLACK (1' PIPE)	1
8	4500655	LOOSE FOUNDATION SET, LEFT AND RIGHT, FOR BOARD PROFILE	1
9	4200104	GRILLE FOR CLEAN-O-FLEX 1000/1040	1
10	4901802	SUPPORT FOUNDATION FOR SLATS, FIBER	1

Fiber_870_995_15

NOTE:

- Plate length: max 4100 mm
(The plate length should be near 4100 mm to avoid waste)
- Bar length: max 6000 mm
(Stiffening bracket per max 1400 mm)
- Distance between foundation sets: max 1500 mm
(If the distance exceeds 1500 mm, a support foundation is mounted)
- Grille against feeder: see Table 1 below

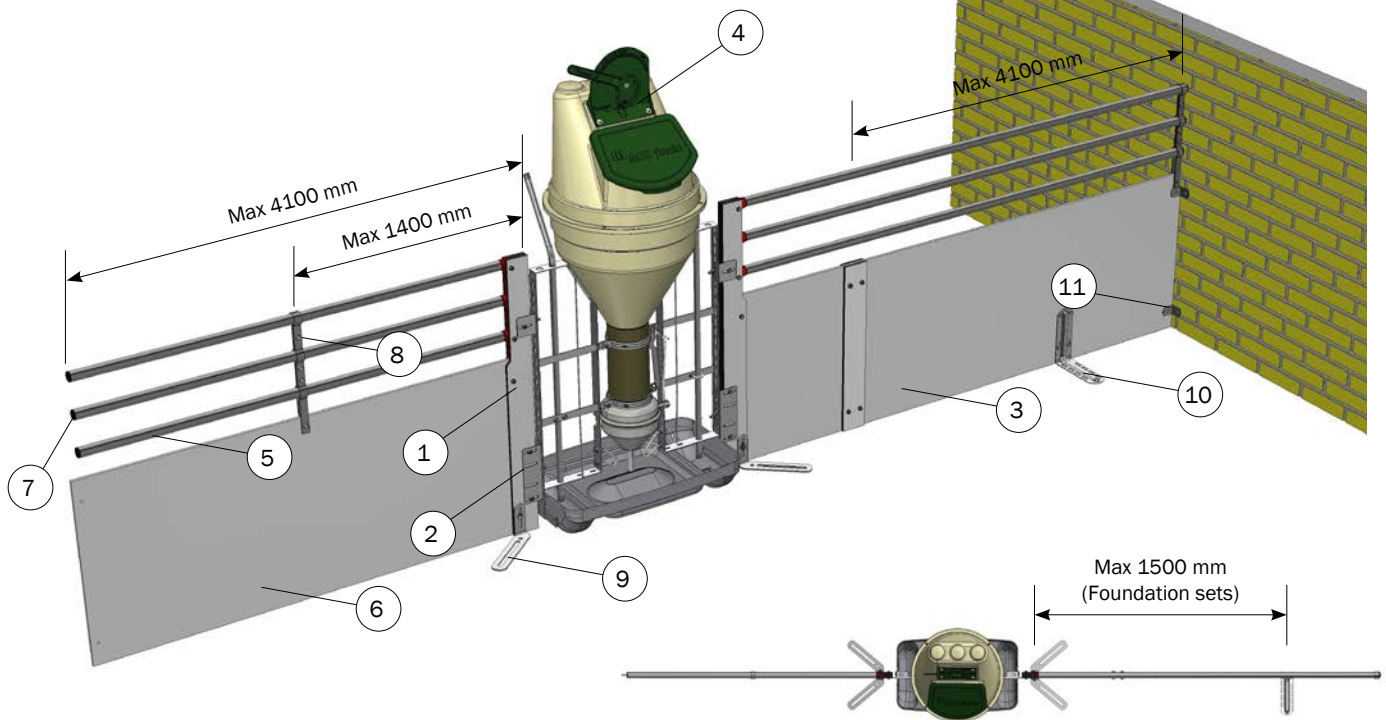

TABLE 1 - GRILLE AGAINST FEEDER

Højde, mm	L = 1040 mm	L = 1260 mm	L = 1540 mm
995	4200104	4200126	4200154
870	4400104	4400126	4400154
745	3200104	3200126	3200154

BILL OF MATERIALS

	Item no.	Description	Pcs.
		<i>FIBER_870_995_15</i>	
1	4600445	POST H100 PLATE FOR 3 BARS/FEEDERS	2
2	38524	MOUNTING KIT FOR U-POST AGAINST FEEDERS	2
3	4560647	SIDE H64,2 PLATE MAX. LENGTH 4100 MM	1
4	560710M	FUNKIMAT WEANER WITH STAINLESS STEEL TROUGH (FLAT-FLAT)	1
5	4610410	3 BARS 1' GALVANIZED, PRICE PER METER	2
6	4510648	SIDE H64,2 PLATE LENGTH 4100-6000 MM	1
7	4500653	3 ROUND CAP BLACK (1' PIPE)	2
8	38944	1 PCS. STIFFENING BRACKET SET FOR 3 BARS ON PLATE	2
9	4500655	LOOSE FOUNDATION SET, LEFT AND RIGHT, FOR BOARD PROFILE	2
10	4901802	SUPPORT FOUNDATION FOR SLATS, FIBER	1
11	4500661	MOUNTING KIT FOR PARTITION AGAINST WALL	1

Fiber_870_995_16

NOTE:

- Plate length: max 4100 mm
(The plate length should be near 4100 mm to avoid waste)
- Bar length: max 6000 mm
(Stiffening bracket per max 1400 mm)
- Distance between foundation sets: max 1500 mm
(If the distance exceeds 1500 mm, a support foundation is mounted)
- Grille against plate: see Table 2 below

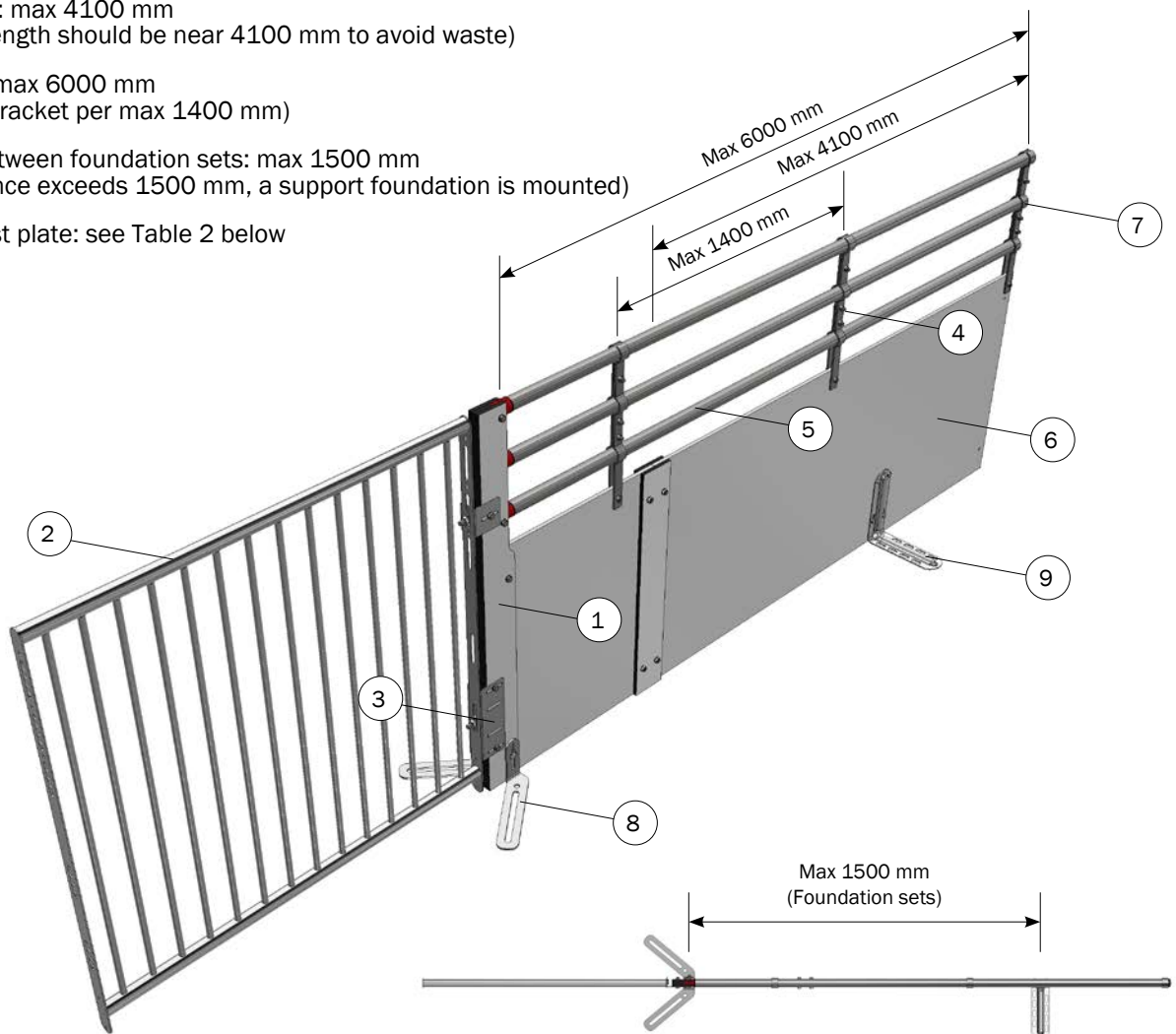

TABLE 2 - GRILLE AGAINST PLATE

Højde, mm	L = 1040 mm	L = 1260 mm	L = 1540 mm
995	4150873	4150874	4150875
870	4450873	4450874	4450875
745	3150873	3150874	3150875

BILL OF MATERIALS

	Item no.	Description	Pcs.
		<i>FIBER_870_995_16</i>	
1	4600445	POST H100 PLATE FOR 3 BARS/FEEDERS	1
2	4150873	STAINLESS STEEL CONTACT GRILLE H:1000 L:1000	1
3	38524	MOUNTING KIT FOR U-POST AGAINST FEEDERS	1
4	4600483	3 PCS STIFFENING BRACKET SET FOR 3 BARS ON PLATE	1
5	4610410	3 BARS 1' GALVANIZED, PRICE PER METER	1
6	4510648	SIDE H64,2 PLATE LENGTH 4100-6000 MM	1
7	4500653	3 ROUND CAP BLACK (1' PIPE)	1
8	4500655	LOOSE FOUNDATION SET, LEFT AND RIGHT, FOR BOARD PROFILE	1
9	4901802	SUPPORT FOUNDATION FOR SLATS, FIBER	1

Fiber_870_995_17

NOTE:

- Plate length: max 4100 mm
(The plate length should be near 4100 mm to avoid waste)
- Bar length: max 6000 mm
(Stiffening bracket per max 1400 mm)
- Distance between foundation sets: max 1500 mm
(If the distance exceeds 1500 mm, a support foundation is mounted)

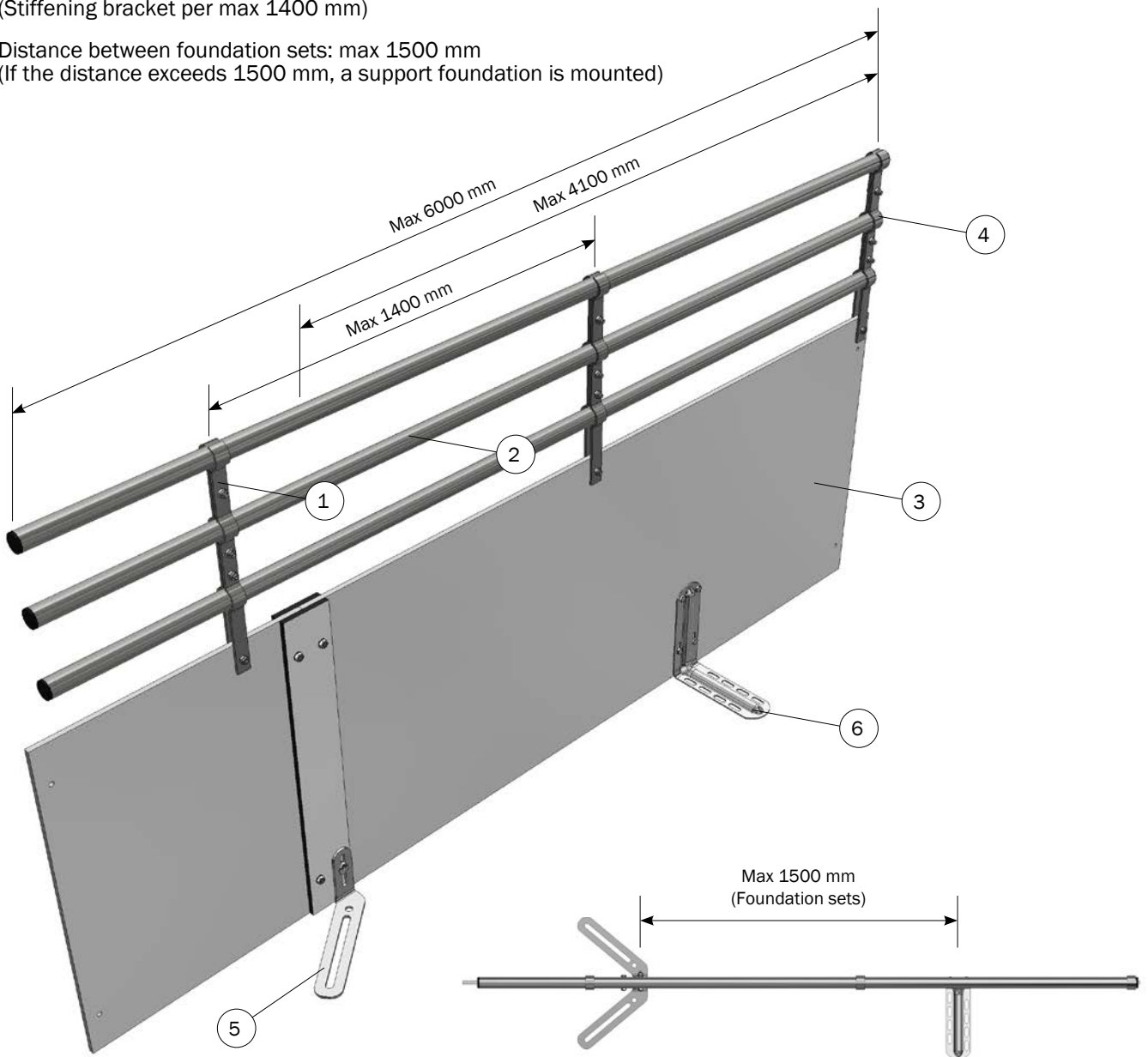

BILL OF MATERIALS			
	Item no.	Description	Pcs.
		<i>FIBER_870_995_17</i>	
1	4600483	3 PCS STIFFENING BRACKET SET FOR 3 BARS ON PLATE	1
2	4610410	3 BARS 1' GALVANIZED, PRICE PER METER	1
3	4510648	SIDE H64,2 PLATE LENGTH 4100-6000 MM	1
4	4500653	3 ROUND CAP BLACK (1' PIPE)	2
5	4500655	LOOSE FOUNDATION SET, LEFT AND RIGHT, FOR BOARD PROFILE	1
6	4901802	SUPPORT FOUNDATION FOR SLATS, FIBER	1

Fiber_870_995_18

NOTE:

- Plate length: max 4100 mm
(The plate length should be near 4100 mm to avoid waste)
- Bar length: max 6000 mm
(Stiffening bracket per max 1400 mm)
- Distance between foundation sets: max 1500 mm
(If the distance exceeds 1500 mm, a support foundation is mounted)

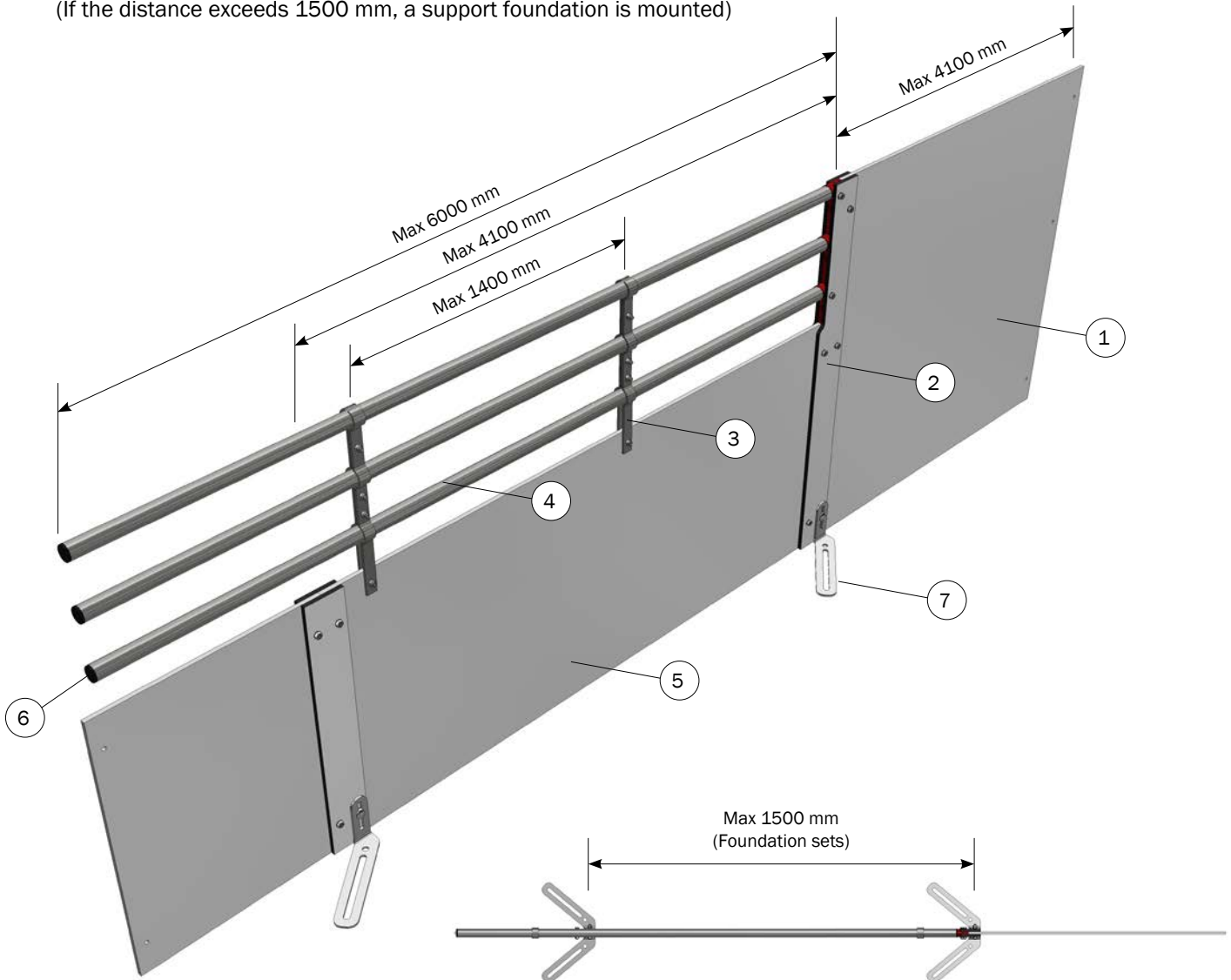

BILL OF MATERIALS			
	Item no.	Description	Pcs.
		<i>FIBER_870_995_18</i>	
1	4660475	SIDE H100 PLATE	1
2	4600440	POST KIT H100 COMBI PLATE/3 BARS	1
3	4600482	2 PCS STIFFENING BRACKET SET FOR 3 BARS ON PLATE	1
4	4610410	3 BARS 1' GALVANIZED, PRICE PER METER	1
5	4510648	SIDE H64,2 PLATE LENGTH 4100-6000 MM	1
6	4500653	3 ROUND CAP BLACK (1' PIPE)	1
7	4500655	LOOSE FOUNDATION SET, LEFT AND RIGHT, FOR BOARD PROFILE	2

Fiber_870_995_19

NOTE:

- Plate length: max 4100 mm
(The plate length should be near 4100 mm to avoid waste)
- Bar length: max 6000 mm
(Stiffening bracket per max 1400 mm)
- Distance between foundation sets: max 1500 mm
(If the distance exceeds 1500 mm, a support foundation is mounted)
- Grille against feeder: see Table 1 below

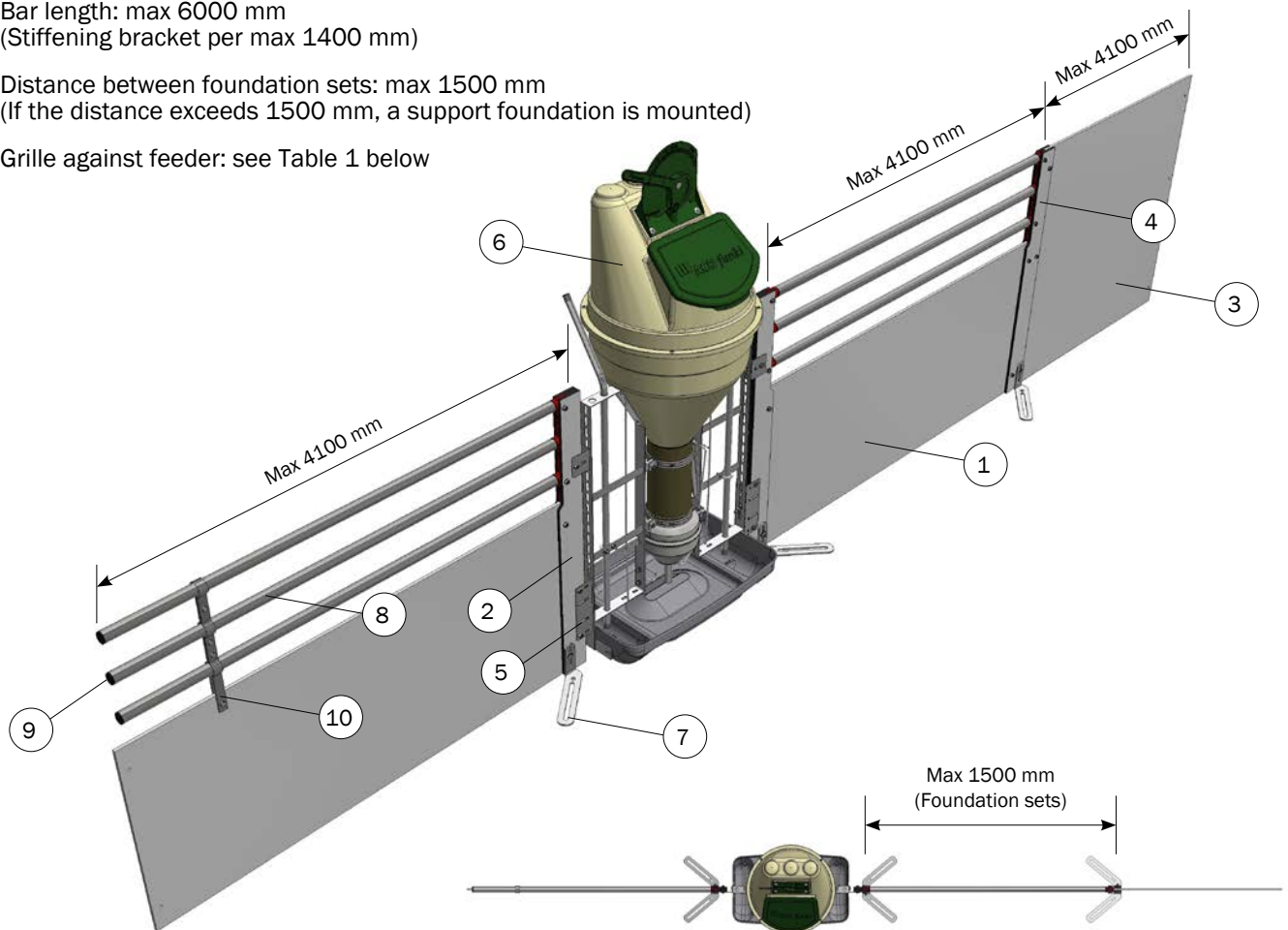

TABLE 1 - GRILLE AGAINST FEEDER

Højde, mm	L = 1040 mm	L = 1260 mm	L = 1540 mm
995	4200104	4200126	4200154
870	4400104	4400126	4400154
745	3200104	3200126	3200154

BILL OF MATERIALS

	Item no.	Description	Pcs.
		<i>FIBER_870_995_19</i>	
1	4560647	SIDE H64,2 PLATE MAX. LENGTH 4100 MM	2
2	4600445	POST H100 PLATE FOR 3 BARS/FEEDERS	2
3	4660475	SIDE H100 PLATE	1
4	4600440	POST KIT H100 COMBI PLATE/3 BARS	1
5	38524	MOUNTING KIT FOR U-POST AGAINST FEEDERS	2
6	560710M	FUNKIMAT WEANER WITH STAINLESS STEEL TROUGH (FLAT-FLAT)	1
7	4500655	LOOSE FOUNDATION SET, LEFT AND RIGHT, FOR BOARD PROFILE	3
8	4610410	3 BARS 1' GALVANIZED, PRICE PER METER	2
9	4500653	3 ROUND CAP BLACK (1' PIPE)	1
10	38944	1 PCS. STIFFENING BRACKET SET FOR 3 BARS ON PLATE	1

Fiber_870_995_20

NOTE:

- Plate length: max 4100 mm
(The plate length should be near 4100 mm to avoid waste)
- Bar length: max 6000 mm
(Stiffening bracket per max 1400 mm)
- Distance between foundation sets: max 1500 mm
(If the distance exceeds 1500 mm, a support foundation is mounted)
- Front part length: max 4100 mm
(Front part hinge side: 300 mm (fixed))
- Gate length: 1200 / 1300 / 600 - 1300 mm
- Front part receiver side > 400 mm, 4610404
Front part receiver side < 400 mm, 4610407

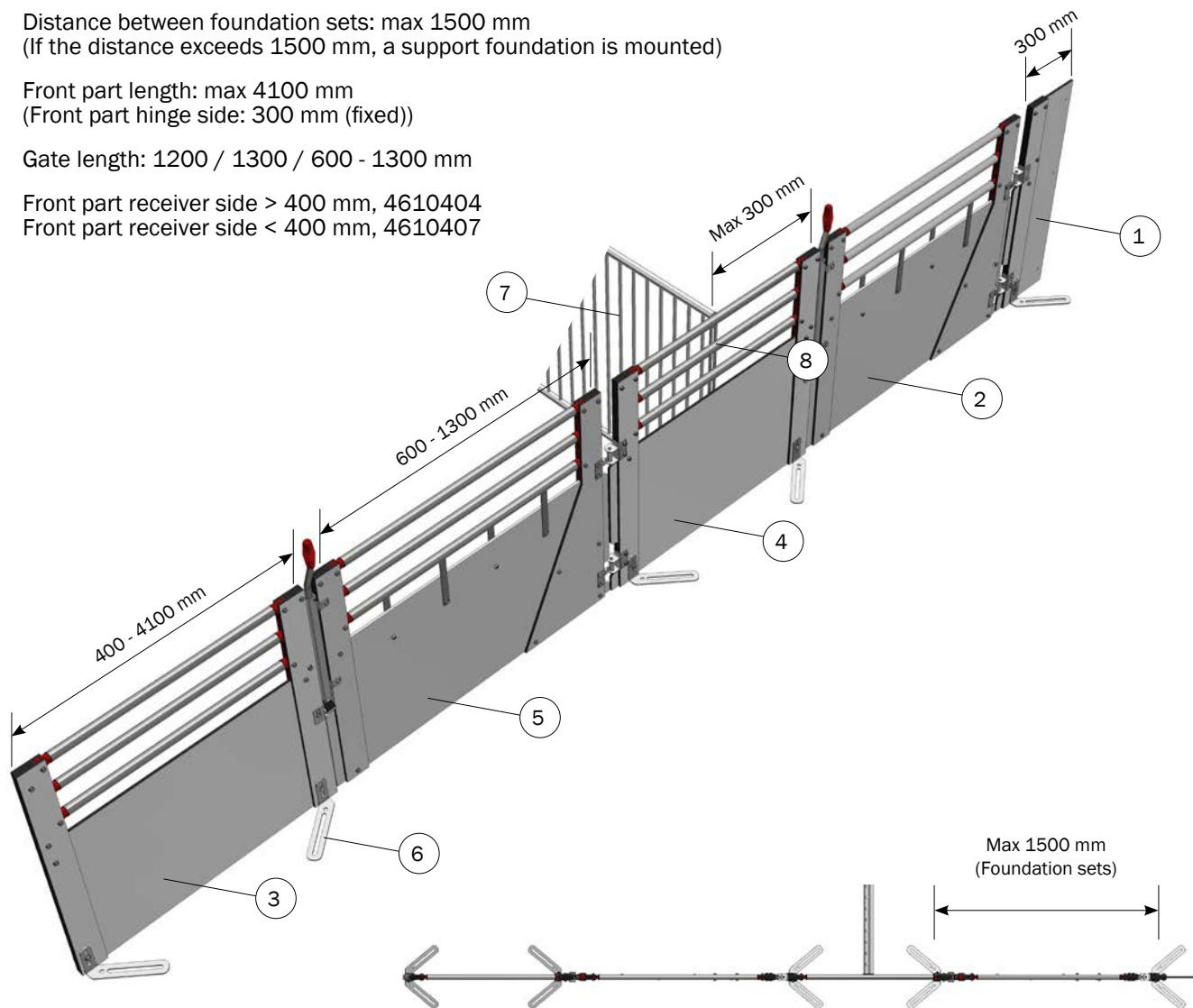

BILL OF MATERIALS			
	Item no.	Description	Pcs.
		<i>FIBER_870_995_20</i>	
1	4610406	FRONT PART H100 PLATE AGAINST WALL/HINGE 300 MM	1
2	4610420	GATE H100 PLATE/3 BARS 120 CM WITH PIN LOCK	1
3	4610404	FRONT PART H100 PLATE/3 BARS WALL/RECEIVER	1
4	4610401	FRONT PART H100 PLATE/3 BARS HINGE/RECEIVER	1
5	4610435	GATE H100 PLATE/3 BARS 60-130CM WITH PIN LOCK	1
6	4500655	LOOSE FOUNDATION SET, LEFT AND RIGHT, FOR BOARD PROFILE	5
7	4150873	STAINLESS STEEL CONTACT GRILLE H:1000 L:1000	1
8	38534	MOUNTING KIT FOR GRILLE COMP-O-FLEX AGAINST FRONT PART	1

Fiber_870_995_21

NOTE:

- Plate length: max 4100 mm
(The plate length should be near 4100 mm to avoid waste)
- Distance between foundation sets: max 1500 mm
(If the distance exceeds 1500 mm, a support foundation is mounted)
- Bar length: max 6000 mm
(Stiffening bracket per max 1400 mm)
- Front part length: max 4100 mm
(Front part hinge side: 300 mm (fixed))
- Gate length: 1200 / 1300 / 600 - 1300 mm
- Front part receiver side > 400 mm, 4610404
Front part receiver side < 400 mm, 4610407

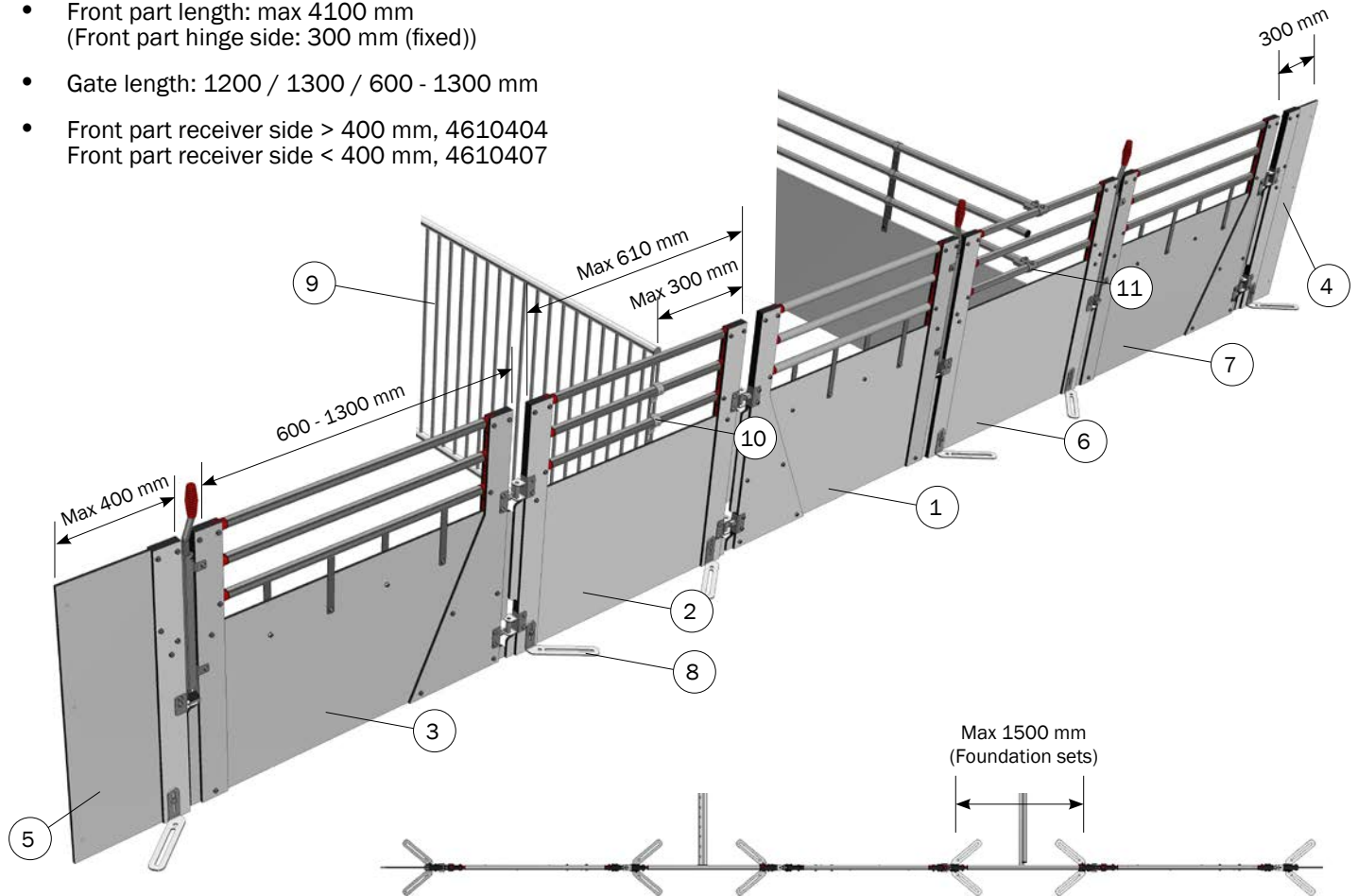

BILL OF MATERIALS

	Item no.	Description	Pcs.
		<i>FIBER_870_995_21</i>	
1	4610420	GATE H100 PLATE/3 BARS 120 CM WITH PIN LOCK	1
2	4610402	FRONT PART H100 PLATE/3 BARS HINGE/HINGE	1
3	4610435	GATE H100 PLATE/3 BARS 60-130CM WITH PIN LOCK	1
4	4610406	FRONT PART H100 PLATE AGAINST WALL/HINGE 300 MM	1
5	4610407	FRONT PART H100 PLATE AGAINST WALL/RECEIVER MAX. 400 MM	1
6	4610403	FRONT PART H100 PLATE/3 BARS RECEIVER/RECEIVER	1
7	4610430	GATE H100 PLATE/3 BARS 120 CM WITH PIN LOCK	1
8	4500655	LOOSE FOUNDATION SET, LEFT AND RIGHT, FOR BOARD PROFILE	6
9	4150873	STAINLESS STEEL CONTACT GRILLE H:1000 L:1000	1
10	38534	MOUNTING KIT FOR GRILLE COMP-O-FLEX AGAINST FRONT PART	1
11	38553	MOUNTING KIT PLATE/2 BARS WITHOUT U-PROFILE AGAINST FRONT PAR	1

Fiber_870_995_22

NOTE:

- Plate length: max 4100 mm
(The plate length should be near 4100 mm to avoid waste)
- Distance between foundation sets: max 1500 mm
(If the distance exceeds 1500 mm, a support foundation is mounted)
- Bar length: max 6000 mm
(Stiffening bracket per max 1400 mm)
- Front part length (full length): max 2000 mm
- Full length gate: 900 - 2500 mm

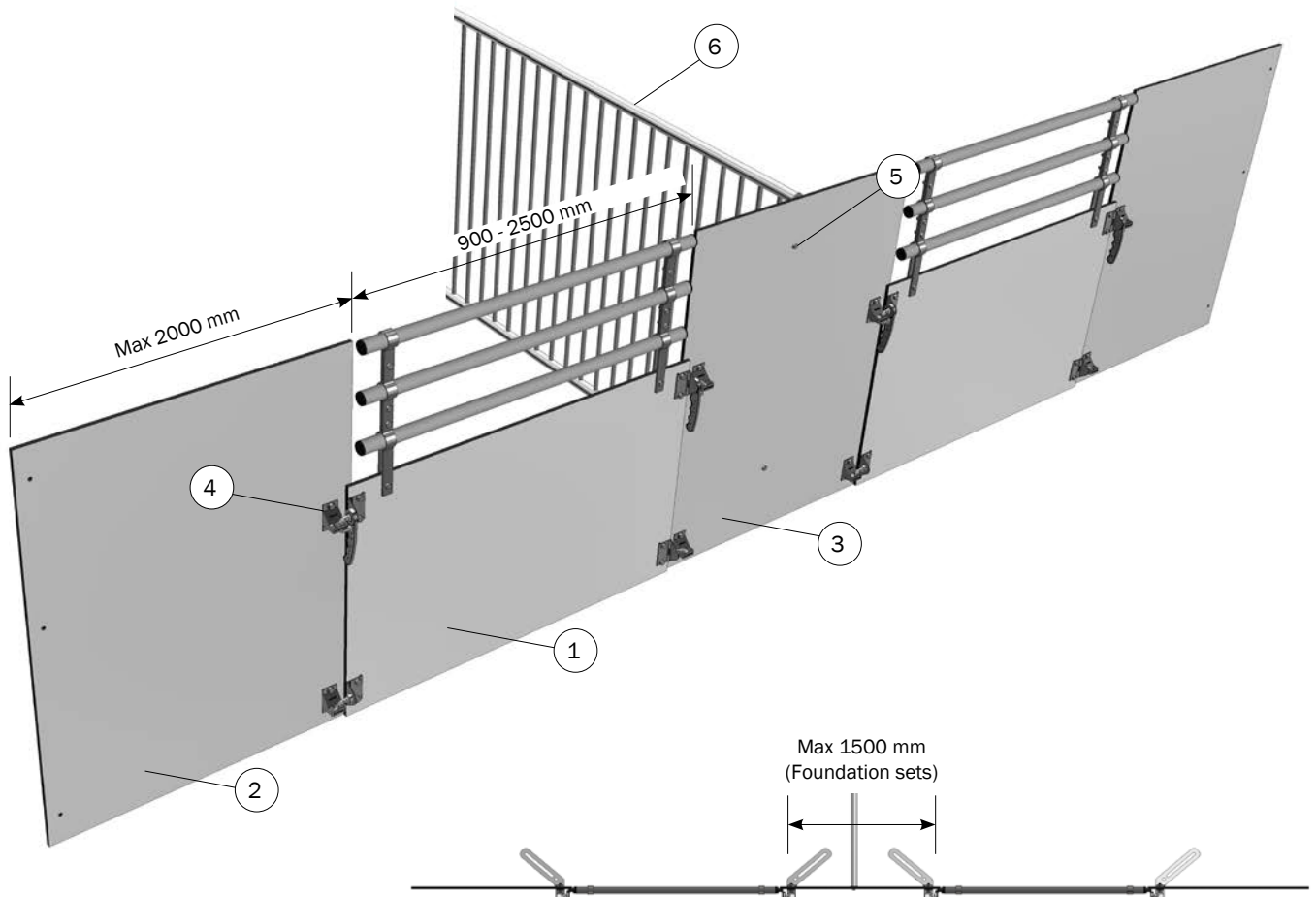

BILL OF MATERIALS

	Item no.	Description	Pcs.
		<i>FIBER_870_995_22</i>	
1	4610465	GATE FULL PEN H100 PLATE/3 BARS 90-250 CM	2
2	4660471	FRONT PART H100 PLATE GATE FULL PEN FOR 2 HINGES	2
3	4660473	FRONT PART H100 PLATE GATE FULL PEN FOR 4 HINGES	1
4	4500644	MOUNTING KIT FOR FRONT PART FOR GATE FULL PEN, INCL. FOUNDATION PLATE	2
5	4500452	MOUNTING KIT FOR GRILL/FRONT PART	1
6	4150873	STAINLESS STEEL CONTACT GRILLE H:1000 L:1000	1

Fiber_870_995_23

NOTE:

- Plate length: max 4100 mm
(The plate length should be near 4100 mm to avoid waste)
- Distance between stabilisation posts: max 2000 mm
For full-height plates, use stabilisation posts 38909 or 38917
- Mount stabilisation posts on both sides of all assembly posts
(Do not mount stabilisations posts directly on the plate, unless it is the outermost plate against e.g. a wall)

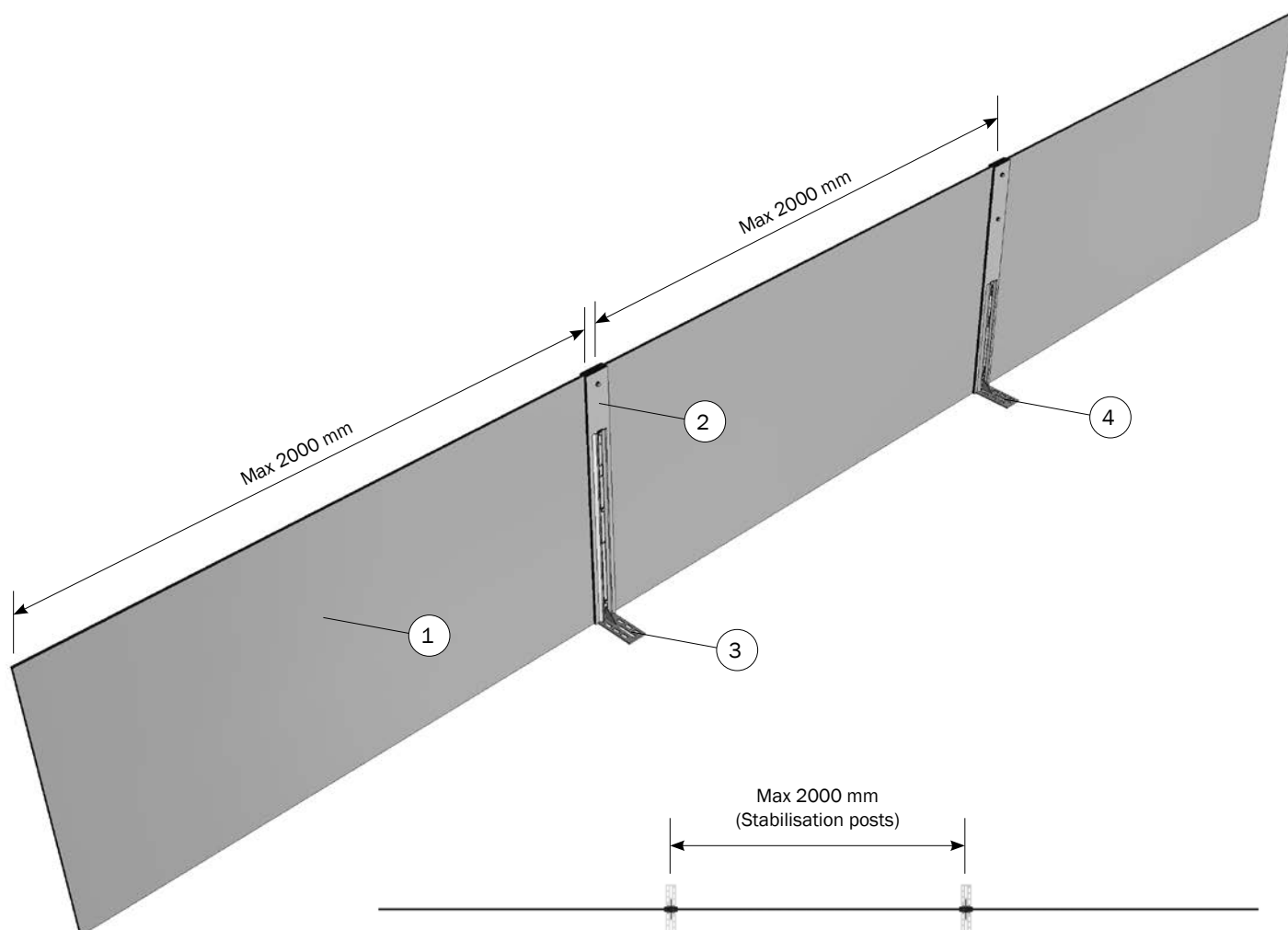

BILL OF MATERIALS

	Item no.	Description	Pcs.
		<i>FIBER_870_995_23</i>	
1	4660451	WASHING WALL H100 PLATE	3
2	4610448	ASSEMBLY KIT FOR WASHING WALL H100	2
3	38909	STABILISATION POST H77,4 CM	2
4	38917	STABILISATION POST H50 CLEAN-O-FLEX 49,5 CM	2