

# DRY FEEDING Feeders

Valid from 1 May 2022

ACO FUNKI A/S

[www.acofunki.com](http://www.acofunki.com)

 EUR



FunkiMat | TUBE-O-MAT | Combi Feeder | Baby Feeder | Box Feeder | CCM Feeder | Downpipes | Water Supply | Aqua Speed

**ACO**  
**FUNKI**



## CONTENTS LIST

TUBE-O-MAT NX VI+ .....	4
TUBE-O-MAT NX CLASSIC .....	5
TURBOMAX .....	7
FUNKIMAT .....	8
DOUBLE FUNKIMAT .....	9
FUNKIMAT ACCESSORIES .....	10
COMBI FEEDER .....	11
BABY FEEDER .....	12
TUBE-O-MAT VI+ .....	13
TUBE-O-MAT CLASSIC .....	15
TUBE-O-MAT VI+ LTD .....	18
TUBE-O-MAT CLASSIC LTD .....	21
TUBE-O-MAT RØR .....	22
TUBE-O-MAT TROUGH .....	23
TUBE-O-MAT AND TUBOMAX ACCESSORIES .....	24
3IN1 NX SPARE PART .....	24
BOX FEEDER - WEANERS .....	26
BOX FEEDER - FINISHERS .....	27
CCM FEEDER .....	29
DOWNPIPE T-PIECE .....	29
DOWNPIPE SOLID PIECE .....	29
DOWNPIPE ACCESSORIES .....	30
DOWNPIPE SOLID PIECE - Ø75 MM OUTLET .....	31
WATER SUPPLY .....	31
8 MM AQUA SPEED .....	34
10 MM AQUA SPEED .....	35
15 MM AQUA SPEED .....	36
TERMS OF SALES AND DELIVERY .....	38

## TUBE-O-MAT NX V+

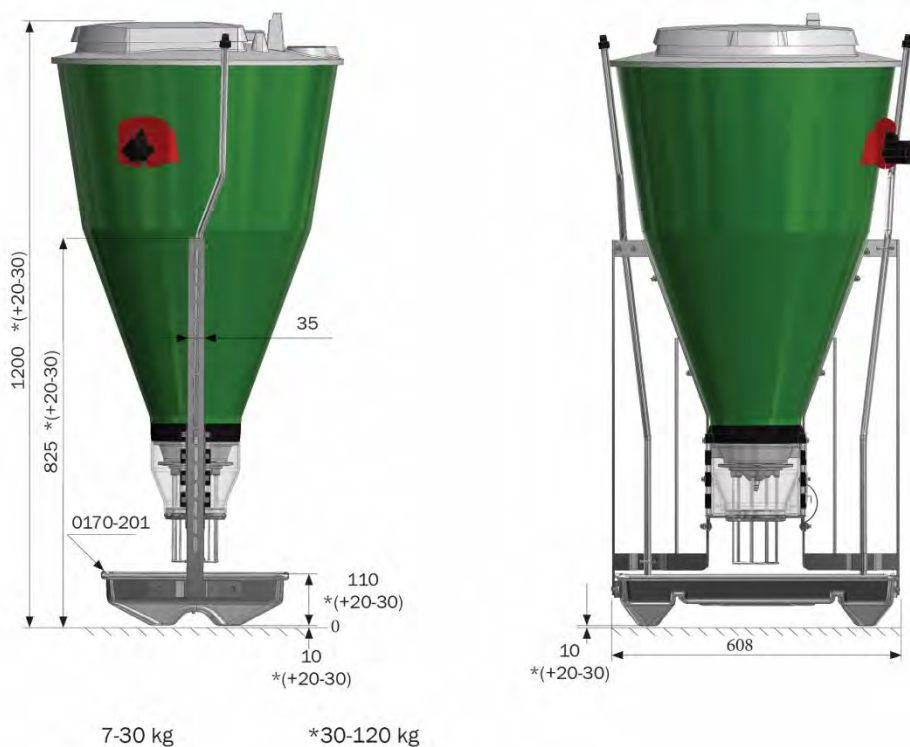

**560155M**

TUBE-O-MAT NX V+  
ASSEMBLED FEEDER

489,00€



**560155U**

TUBE-O-MAT NX V+  
UNASSEMBLED FEEDER

457,00€



**72391**

TUBE-O-MAT@ VIP/VI+ SPIRAL LARGE

4,00€

**72177**

TUBE-O-MAT@ VI+ PIN DOSING UNIT  
ACCESSORIES FOR FEEDERS

4,00€



**72175**

TUBE-O-MAT@ VI+ DOSING UNIT

66,50€



**70750**  
 BOTTOM FOR HOPPER VI+  
 ACCESSORIES FOR FEEDERS

12,00€



**70752**  
 TUBE-O-MAT® VI+ COVER PART VI+ TRANSPARE  
 ACCESSORIES FOR FEEDERS

15,50€



**72181**  
 TUBE-O-MAT® VI+ SLIDING LATCH \*A  
 ACCESSORIES FOR FEEDERS

4,50€



**72367**  
 TUBE-O-MAT® VIP/VI+ LIFTER CPL.

7,50€



**72371**  
 TUBE-O-MAT® LIFTER/SPIRAL GUIDANCE 8MM

2,50€









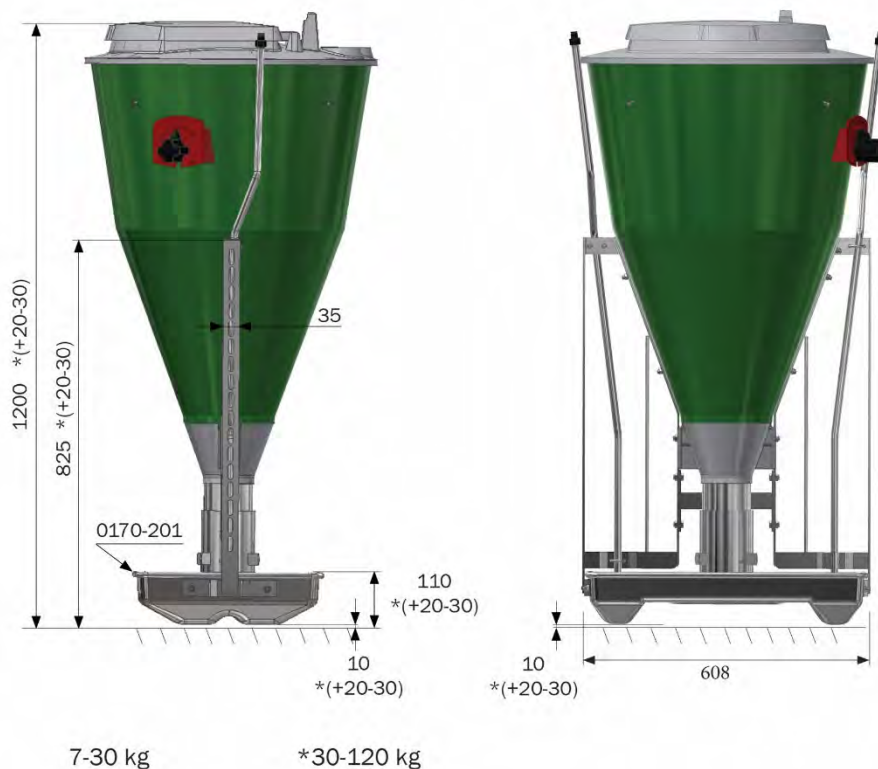





**67104**  
 M5 X 25 PAN HEAD SCREW PH DIN7985 A2

0,50€

## TUBE-O-MAT NX CLASSIC



	<b>560165M</b> TUBE-O-MAT NX CLASSIC ASSEMBLED FEEDER	459,00€
	<b>560165U</b> TUBE-O-MAT NX CLASSIC UNASSEMBLED FEEDER	432,50€
	<b>72316</b> TUBE-O-MAT® ADJ. HANDLE INCL. TURN ROD	16,00€
	<b>72371</b> TUBE-O-MAT® LIFTER/SPIRAL GUIDANCE 8MM	2,50€
	<b>72374</b> TUBE-O-MAT® TOP/PIGNIC ROTORHOVED U/LÅS	2,50€
	<b>67104</b> M5 X 25 PAN HEAD SCREW PH DIN7985 A2	0,50€
	<b>70745</b> PIG NIC COLLAR FOR TUBE-O-MAT CLASSIC ACCESSORIES FOR TUBE-O-MAT CLASSIC	30,75€
<b>TUBE-O-MAT NX Accessories</b>		
	<b>550580</b> HOPPER FOR 3IN1 NX 120 L	79,50€
	<b>550588</b> TOP FOR 3IN1 NX, WHITE	13,50€
	<b>550589</b> TOP LID 3IN1 NX, WHITE	9,50€
	<b>93245</b> PRESS NIPPLE TUBE-O-MAT® 3/8"INTERNAL THREAD	7,00€
	<b>18849</b> 3IN1 STRUT OVER GALVANIZE ACCESSORIES FOR FEEDERS	10,00€

## TURBOMAX

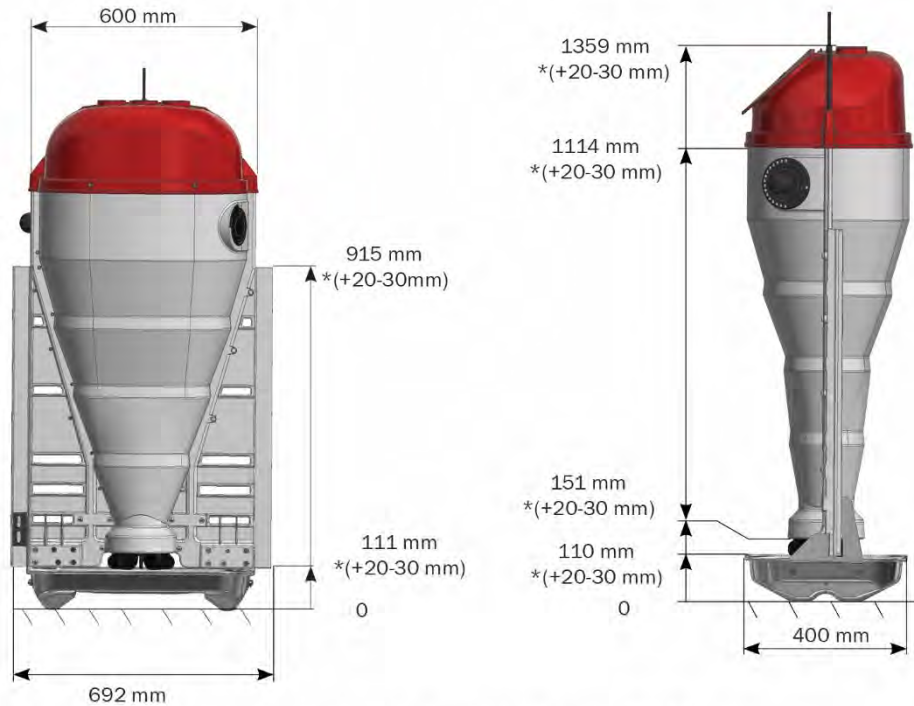

Measurements marked with \* apply to finishers (30-120 kg).  
Rest measurements apply to piglets (7-30 kg).

**560180M**TURBOMAX FEEDER 7-30 KG  
ASSEMBLED FEEDER

392,50€

**560180U**TURBOMAX FEEDER 7-30 KG  
UNASSEMBLED FEEDER

346,50€

**560185M**TURBOMAX FEEDER 30-120 KG  
ASSEMBLED FEEDER

392,50€

**560185U**TURBOMAX FEEDER 30-120 KG  
UNASSEMBLED FEEDER

346,50€

**0228-276**

STAINLESS STEEL POST FOR FEEDER

66,50€



0228-231

10,00€

DRINKING VALVE SET FOR FEEDER

## Funkimat

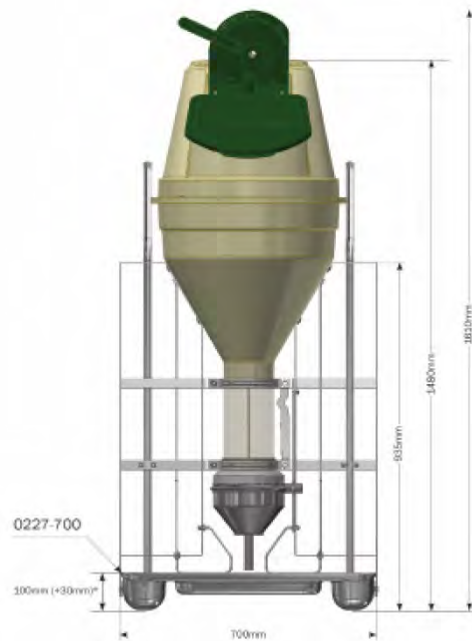

\*The height of 0227-701 trough for finisher is 130 mm



560710M

529,00€

FUNKIMAT WEANER WITH STAINLESS STEEL TROUGH (FLAT-FLAT)  
ASSEMBLED FEEDER



560710U

502,50€

FUNKIMAT WEANER WITH STAINLESS STEEL TROUGH (FLAT-FLAT)  
UNASSEMBLED FEEDER



560711M

534,50€

FUNKIMAT FINISHER WITH STAINLESS STEEL TROUGH (FLAT-FLAT)  
ASSEMBLED FEEDER



560711U

507,50€

FUNKIMAT FINISHER WITH STAINLESS STEEL TROUGH (FLAT-FLAT)  
UNASSEMBLED FEEDER



0227-088

12,50€

DOSAGE DISC VER. 3



0227-309

12,00€

DOSAGE DISC VER. 4 SMALL





**0227-370**

9,00€

RATAINER SPRING FOR DOSAGE DEVICE, STAINLESS STEEL FUNKIMAT VER. 2



**38524**

18,50€

MOUNT KIT FOR U-POST AGAINST FEEDERS

## Double Funkimat

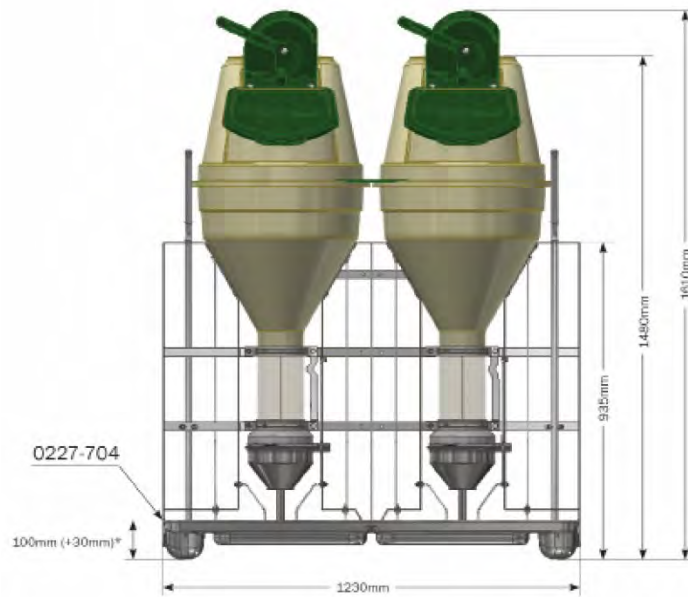

\*The height of 0227-705 trough for finisher is 130 mm



**0227-670**

697,50€

DOUBLE FUNKIMAT (FLAT-FLAT) - UNASSEMBLED



**0227-714**

171,50€

ST TROUGH WEANER FOR DOUBLE FUNKIMAT, COMPLET



**0227-715**

172,50€

ST TROUGH FINISHER FOR DOUBLE FUNKIMAT, COMPLET



**0227-800**

927,50€

DOUBLE FUNKIMAT (FLAT-FLAT) WEANER MOUNTED



**0227-900**

928,50€

DOUBLE FUNKIMAT (FLAT-FLAT) FINISHER - MOUNTED



**38524**

MOUNT KIT FOR U-POST AGAINST FEEDERS

18,50€

## Funkimat Accessories



**0227-440**

DOSAGE DEVICE FOR FUNKIMAT, ASSEMBLED

234,00€



**0227-438**

LOWER STAINLESS FUNNEL VER. 3

105,00€



**0227-319**

CROSS FOR PREVENTING BLOCKING OF FEED FOR FUNKIMAT AND 3IN1ROTO

44,50€



**0227-558**

FLOOR PLATE FOR DOUBLE FUNKIMAT AND 3N1 ROTO 10X1200X1200 MM  
LDPE STRUCTURE FOR UNDER FEEDERS

68,00€



**0227-559**

FLOOR PLATE FOR SINGLE FUNKIMAT AND 3IN1 ROTO 10X670X1200 MM  
LDPE STRUCTURE UNDER FEEDERS

45,50€



**0228-276**

STAINLESS STEEL POST FOR FEEDER

66,50€



**0227-274**

SOLID POST FOR FEED DISPENSER, 950MM

59,50€



**0227-150**

ST TROUGH FOOT ADJUSTABLE FOR FEEDER

37,00€



**12100107**

DRINKING VALVE 1/2" ST TYPE 13  
DRINKING VALVE

9,00€



**0227-580**

WATER CONNECTING FOR SINGEL FEEDER 10 MM AQUASPEED WITH 1/2" OUTSIDE  
THREAD

21,50€



**0227-587**

HANGER FOR FEEDING PIPE

21,50€



**0227-579**

WATER CONNECTING FOR DOUBLE FEEDERS, 10MM AQUASPEED WITH 1/2" OUTSIDE THREAD

23,50€



**0227-597**

HANGER FOR FEEDING PIPE

38,50€

## Combi Feeder



**0227-495**

COMBI FEEDER COMPLET

441,50€



**0227-480**

WATERPIPE FOR COMBI FEEDER

43,00€

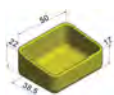

**09550**

SINGLE TROUGH T35-50, FOR ENCASED IN CONCRETE

51,45€

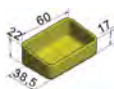

**09552**

SINGLE TROUGH T35-60, FOR ENCASED IN CONCRETE

55,75€

## Baby Feeder

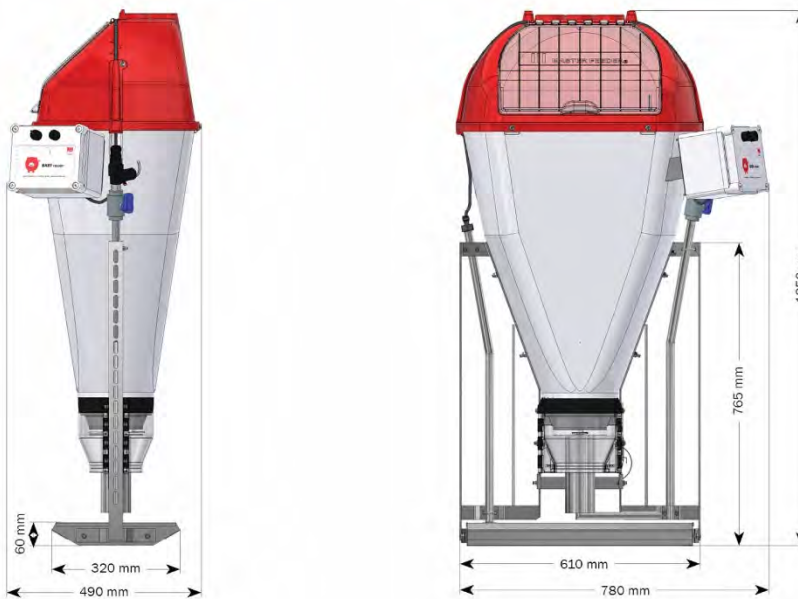

**0229-000**  
BABY FEEDER  
ASSEMBLED FEEDER

1912,50€



**0229-001**  
PLATE AND ACCESSORIES FOR STAND-ALONE BABY FEEDER  
ACCESSORIES TO BABY FEEDER

68,00€



**0229-034**  
DOSAGE DISC Ø129 LDPE  
ACCESSORIES FOR FEEDERS

10,00€



**0229-033**  
DOSAGE DISC Ø125 LDPE  
ACCESSORIES FOR FEEDERS

10,00€



**72177**  
TUBE-O-MAT® VI+ PIN DOSING UNIT  
ACCESSORIES FOR FEEDERS

4,00€



**70752**  
TUBE-O-MAT® VI+ COVER PART VI+ TRANSPARE  
ACCESSORIES FOR FEEDERS

15,50€



**72181**  
TUBE-O-MAT® VI+ SLIDING LATCH \*A  
ACCESSORIES FOR FEEDERS

4,50€

## TUBE-O-MAT® VI+

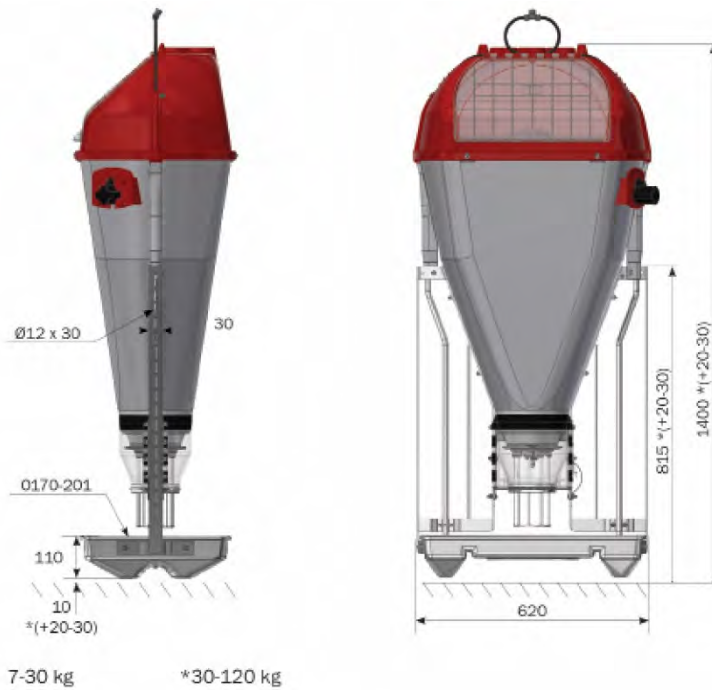

**89550M**

TUBE-O-MAT® VI+ WTF  
ASSEMBLED FEEDER

451,50€



**89550U**

TUBE-O-MAT® VI+ WTF  
UNASSEMBLED FEEDER

420,50€



**89560M**

TUBE-O-MAT® VI+ FINISHER  
ASSEMBLED FEEDER

432,50€



**89560U**

TUBE-O-MAT® VI+ FINISHER  
UNASSEMBLED FEEDER

401,50€

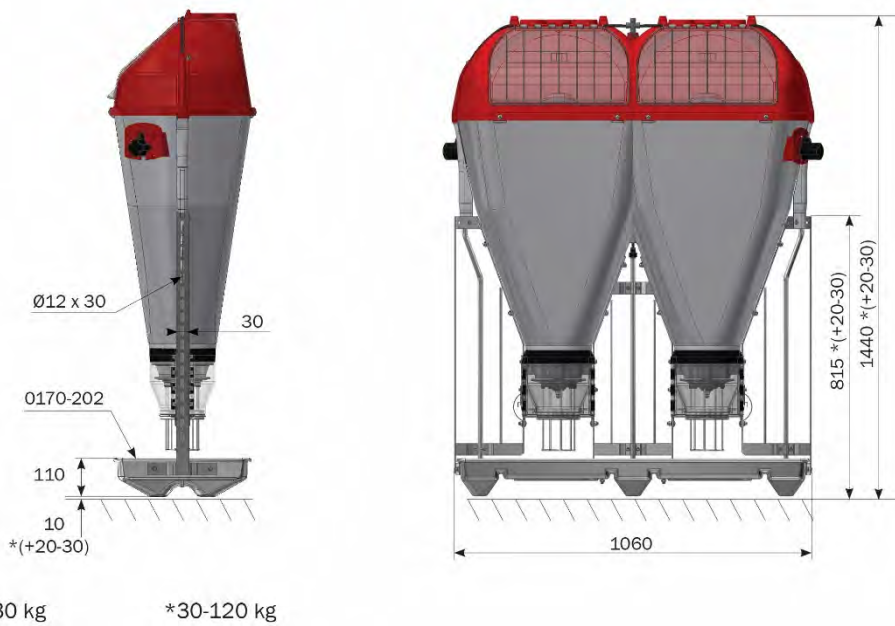

**89650M**

TUBE-O-MAT® VI+JUMBO WTF  
ASSEMBLED FEEDER

743,50€



**89650U**

TUBE-O-MAT® VI+ JUMBO WTF  
UNASSEMBLED FEEDER

666,50€



**89660M**

TUBE-O-MAT® VI+ JUMBO FINISHER  
ASSEMBLED FEEDER

743,50€



**89660U**

TUBE-O-MAT® VI+ JUMBO FINISHER  
UNASSEMBLED FEEDER

666,50€



**38524**

MOUNT KIT FOR U-POST AGAINST FEEDERS

18,50€



**70711**

TUBE-O-MAT® HOPPER 2008  
ACCESSORIES FOR FEEDERS











81,00€



**70723**

TUBE-O-MAT® JUMBO HOPPER 2008

75,50€

	<b>73720</b> TUBE-O-MAT® JUMBO 2008 LID PART FIXED	47,00€
	<b>73700</b> LID PART HINGED TUBE-O-MAT® 2008 ACCESSORIES FOR FEEDERS	11,00€
	<b>73701</b> TUBE-O-MAT® 2008 HINGE PIN HATCH 2008 ACCESSORIES FOR FEEDERS	2,00€
	<b>72391</b> TUBE-O-MAT® VIP/VI+ SPIRAL LARGE	4,00€
	<b>76262</b> MOUNTING KIT FEEDING PARTS FOR TUBE-O-MAT AND LTD VI+ ACCESSORIES FOR FEEDERS	128,00€
	<b>93245</b> PRESS NIPPLE TUBE-O-MAT® 3/8"INTERNAL THREAD	7,00€
	<b>72177</b> TUBE-O-MAT® VI+ PIN DOSING UNIT ACCESSORIES FOR FEEDERS	4,00€
	<b>72175</b> TUBE-O-MAT® VI+ DOSING UNIT	66,50€
	<b>70752</b> TUBE-O-MAT® VI+ COVER PART VI+ TRANSPARE ACCESSORIES FOR FEEDERS	15,50€
	<b>70750</b> BOTTOM FOR HOPPER VI+ ACCESSORIES FOR FEEDERS	12,00€
	<b>72181</b> TUBE-O-MAT® VI+ SLIDING LATCH *A ACCESSORIES FOR FEEDERS	4,50€

## TUBE-O-MAT® CLASSIC

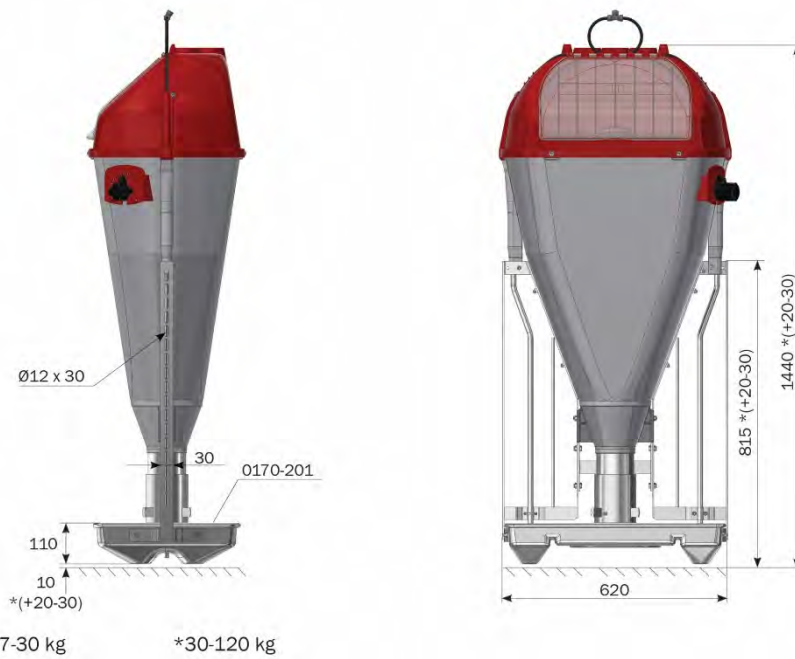

**89585M**

TUBE-O-MAT® CLASSIC WTF  
ASSEMBLED FEEDER

428,50€



**89585U**

TUBE-O-MAT® CLASSIC WTF  
UNASSEMBLED FEEDER

398,00€



**89587M**

TUBE-O-MAT® CLASSIC FINISHER  
ASSEMBLED FEEDER

403,50€



**89587U**

TUBE-O-MAT® CLASSIC FINISHER  
UNASSEMBLED FEEDER

379,00€



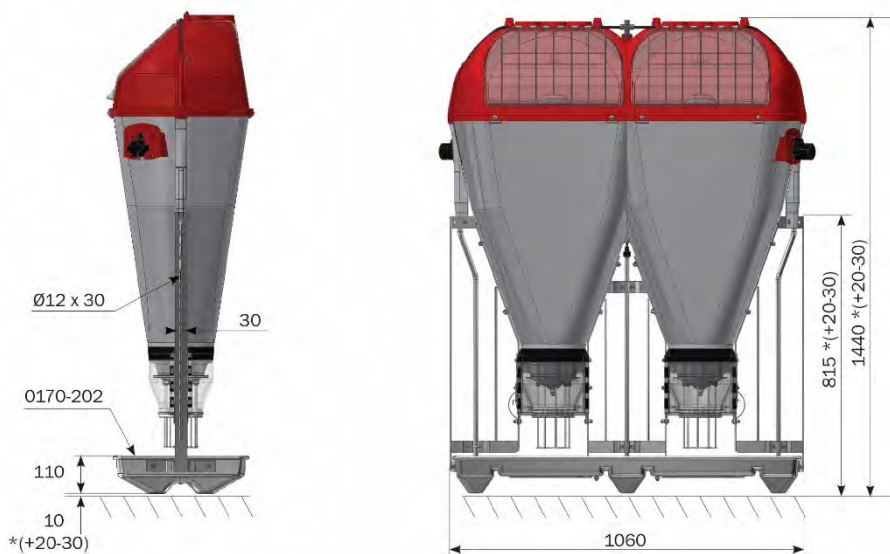

7-30 kg

\*30-120 kg



**89685M**

TUBE-O-MAT® CLASSIC JUMBO WTF  
ASSEMBLED FEEDER

690,50€



**89685U**

TUBE-O-MAT® CLASSIC JUMBO WTF  
UNASSEMBLED FEEDER

621,00€



**89687M**

TUBE-O-MAT® CLASSIC JUMBO FINISHER  
ASSEMBLED FEEDER

690,50€



**89687U**

TUBE-O-MAT® CLASSIC JUMBO FINISHER  
UNASSEMBLED FEEDER

621,00€



**38524**

MOUNT KIT FOR U-POST AGAINST FEEDERS

18,50€



**70711**

TUBE-O-MAT® HOPPER 2008  
ACCESSORIES FOR FEEDERS









81,00€



**70723**

TUBE-O-MAT® JUMBO HOPPER 2008

75,50€

	<b>73710</b> HATCH RED 0.8% UV TUBE-O-MAT® 2008 ACCESSORIES FOR FEEDERS	30,00€
	<b>73720</b> TUBE-O-MAT® JUMBO 2008 LID PART FIXED	47,00€
	<b>73700</b> LID PART HINGED TUBE-O-MAT® 2008 ACCESSORIES FOR FEEDERS	11,00€
	<b>73701</b> TUBE-O-MAT® 2008 HINGE PIN HATCH 2008 ACCESSORIES FOR FEEDERS	2,00€
	<b>72395</b> HELIX SMALL	4,00€
	<b>76275</b> MOUNTING KIT FEEDING PARTS FOR TUBE-O-MAT AND LTD CLASSIC	90,50€
	<b>93245</b> PRESS NIPPLE TUBE-O-MAT® 3/8"INTERNAL THREAD	7,00€
	<b>70745</b> PIG NIC COLLAR FOR TUBE-O-MAT CLASSIC ACCESSORIES FOR TUBE-O-MAT CLASSIC	30,75€

**TUBE-O-MAT® VI+ LTD.**

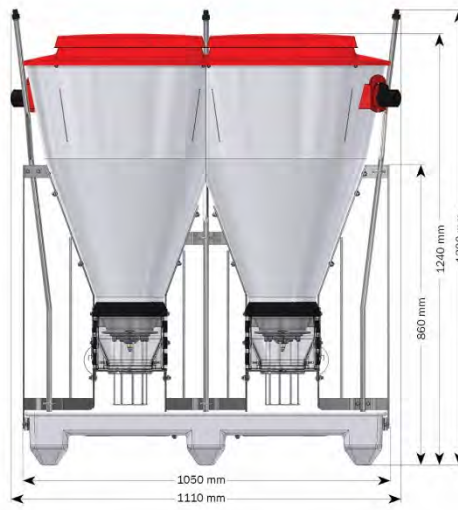
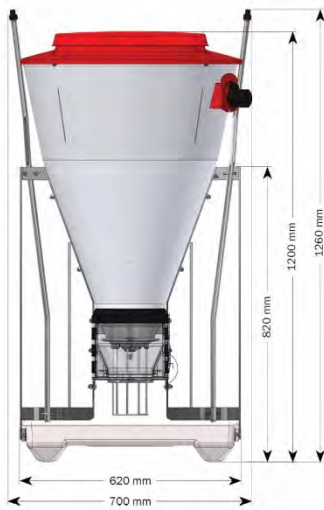

**89551U**  
TUBE-O-MAT® VI+ LTD. WTF  
UNASSEMBLED FEEDER

421,50€



**89561U**  
TUBE-O-MAT® VI+ LTD. FINISHER  
UNASSEMBLED FEEDER

403,00€



**89651U**  
TUBE-O-MAT® VI+ LTD. JUMBO WTF  
UNASSEMBLED FEEDER

682,50€



**89661U**  
TUBE-O-MAT® VI+ LTD. JUMBO FINISHER  
UNASSEMBLED FEEDER

682,50€



**38524**  
MOUNT KIT FOR U-POST AGAINST FEEDERS

18,50€



**70710**  
HOPPER TUBE-O-MAT® 2001 (ROUND)

76,50€















**70725**  
TUBE-O-MAT® JUMBO HOPPER ROUND

75,50€



**89462**  
TUBE-O-MAT® LID PART FIXED

24,50€

	<b>89464</b> TUBE-O-MAT® JUMBO LID PART FIXED	44,00€
	<b>89458</b> LID PART HINGED TUBE-O-MAT® 2005	22,50€
	<b>72391</b> TUBE-O-MAT® VIP/VI+ SPIRAL LARGE	4,00€
	<b>76262</b> MOUNTING KIT FEEDING PARTS FOR TUBE-O-MAT AND LTD VI+ ACCESSORIES FOR FEEDERS	128,00€
	<b>93245</b> PRESS NIPPLE TUBE-O-MAT® 3/8"INTERNAL THREAD	7,00€
	<b>72177</b> TUBE-O-MAT® VI+ PIN DOSING UNIT ACCESSORIES FOR FEEDERS	4,00€
	<b>72175</b> TUBE-O-MAT® VI+ DOSING UNIT	66,50€
	<b>70752</b> TUBE-O-MAT® VI+ COVER PART VI+ TRANSPARE ACCESSORIES FOR FEEDERS	15,50€
	<b>70750</b> BOTTOM FOR HOPPER VI+ ACCESSORIES FOR FEEDERS	12,00€
	<b>72181</b> TUBE-O-MAT® VI+ SLIDING LATCH *A ACCESSORIES FOR FEEDERS	4,50€
	<b>72371</b> TUBE-O-MAT® LIFTER/SPIRAL GUIDANCE 8MM	2,50€
	<b>72374</b> TUBE-O-MAT® TOP/PIGNIC ROTORHOVED U/LÅS	2,50€
	<b>67104</b> M5 X 25 PAN HEAD SCREW PH DIN7985 A2	0,50€

## TUBE-O-MAT® CLASSIC LTD.

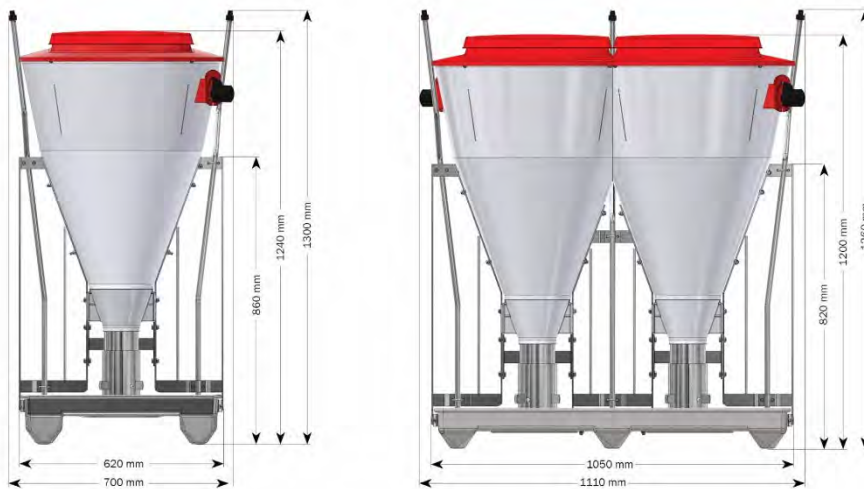

**89590U**

TUBE-O-MAT® CLASSIC LTD. WTF  
UNASSEMBLED FEEDER

399,00€



**89595U**

TUBE-O-MAT® CLASSIC LTD. FINISHER  
UNASSEMBLED FEEDER

380,00€



**89690U**

TUBE-O-MAT® CLASSIC LTD. JUMBO WTF  
UNASSEMBLED FEEDER

637,00€



**89695U**

TUBE-O-MAT® CLASSIC LTD. JUMBO FINISHER  
UNASSEMBLED FEEDER

637,00€



**38524**

MOUNT KIT FOR U-POST AGAINST FEEDERS

18,50€



**70710**

HOPPER TUBE-O-MAT® 2001 (ROUND)

76,50€



**70725**

TUBE-O-MAT® JUMBO HOPPER ROUND









75,50€



**89462**

TUBE-O-MAT® LID PART FIXED

24,50€

	<b>89464</b> TUBE-O-MAT® JUMBO LID PART FIXED	44,00€
	<b>89458</b> LID PART HINGED TUBE-O-MAT® 2005	22,50€
	<b>72395</b> HELIX SMALL	4,00€
	<b>76275</b> MOUNTING KIT FEEDING PARTS FOR TUBE-O-MAT AND LTD CLASSIC	90,50€
	<b>93245</b> PRESS NIPPLE TUBE-O-MAT® 3/8"INTERNAL THREAD	7,00€
	<b>70745</b> PIG NIC COLLAR FOR TUBE-O-MAT CLASSIC ACCESSORIES FOR TUBE-O-MAT CLASSIC	30,75€
	<b>72371</b> TUBE-O-MAT® LIFTER/SPIRAL GUIDANCE 8MM	2,50€
	<b>72374</b> TUBE-O-MAT® TOP/PIGNIC ROTORHOVED U/LÅS	2,50€
	<b>67104</b> M5 X 25 PAN HEAD SCREW PH DIN7985 A2	0,50€

## TUBE-O-MAT® PIPE

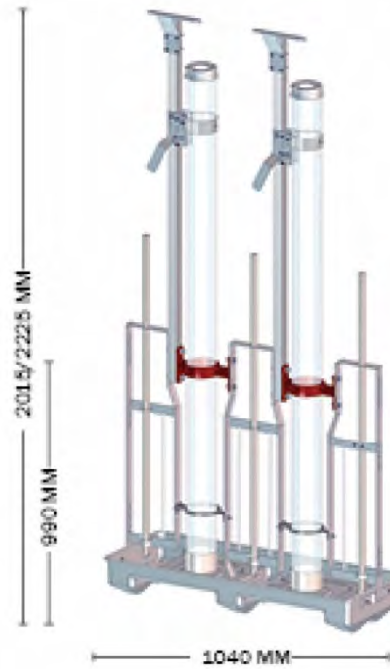
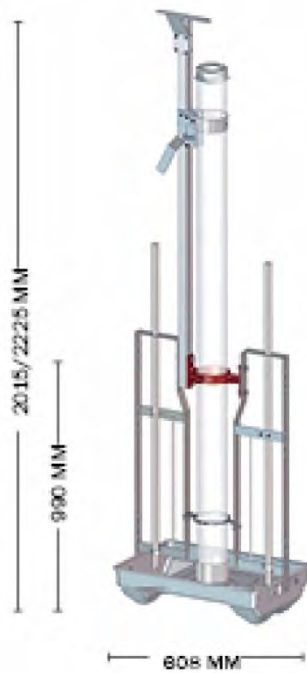

**89504M**  
TUBE-O-MAT® TUBE FINISHER  
ASSEMBLED FEEDER

482,00€



**89504U**  
TUBE-O-MAT® TUBE FINISHER  
UNASSEMBLED FEEDER

462,50€



**89684M**  
TUBE-O-MAT® TUBE JUMBO FINISHER  
ASSEMBLED FEEDER

840,00€



**89684U**  
TUBE-O-MAT® TUBE JUMBO FINISHER  
UNASSEMBLED FEEDER

786,00€

## TUBE-O-MAT Trough



**71008**  
TROUGH VI+ WTF, 11 X 40 X 60 CM

68,50€





**71009**  
TROUGH VI+ AND TUBE FINISHERS, 15 X 40 X 60 CM

62,50€

	<b>71029</b> TROUGH CLASSIC WTF, 11 X 40 X 60 CM ACCESSORIES FOR FEEDERS	94,00€
---	--	--------

	<b>71030</b> TROUGH CLASSIC FINISHER, 15 X 40 X 60 CM	75,00€
---	--	--------

	<b>71070</b> TROUGH CLASSIC FINISHER JUMBO, 15 X 40 X 103,5 CM	137,00€
---	---	---------

	<b>0170-201</b> SINGLE TROUGH TOM V+ AND CLASSIC WTF 11X40X60 CM	74,00€
---	---	--------

	<b>0170-202</b> DOUBLE TROUGH TOM V+ AND CLASSIC 11X40X103 CM	107,00€
---	--	---------

## TUBE-O-MAT AND TUBOMAX Accessories

	<b>74501</b> FOOT BRACKET 16/18 CM - FINISHER TUBE-O-MAT®	12,50€
---	--	--------

	<b>74502</b> FOOT BRACKET 12/18 CM - WTF TUBE-O-MAT®	11,50€
---	---	--------

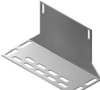
	<b>74503</b> FOOT BRACKET 16/25 CM - FINISHER TUBE-O-MAT®	23,50€
---	--	--------













	<b>74504</b> FOOT BRACKETS WTF	16,50€
---	-----------------------------------	--------

	<b>89014</b> FLOOR PLATE FOR SINGLE TUBE-O-MAT 10X608X1200 MM LDPE STRUCTURE UNDER FEEDERS	53,50€
---	--	--------

	<b>89016</b> FLOOR PLATE FOR DOUBLE TUBE-O-MAT 10X1040X1200 MM LDPE STRUCTURE UNDER FEEDERS	77,00€
---	---	--------

## 3IN1 NX spare part



	<b>550580</b> HOPPER FOR 3IN1 NX 120 L	79,50€
	<b>550588</b> TOP FOR 3IN1 NX, WHITE	13,50€
	<b>550589</b> TOP LID 3IN1 NX, WHITE	9,50€
	<b>560597</b> ACCESSORIES BOX, 3IN1 NX VERS. 2	153,00€
	<b>18724</b> THREE-LEG, 3-IN-1 PLASTIC HOPPER, 96 CM	41,00€
	<b>550599</b> BOTTOM HOPPER FOR 3IN1 FEEDER	6,50€
	<b>281523</b> FEEDING PIPE 3IN1 WITH PLASTIC COLLAR	63,50€
	<b>18723</b> FEEDINGTUBE, WITH STAINLESS STEEL COLLAR FOR 3IN1 FEEDER	100,50€
	<b>18848</b> GUIDE RING STAINLESS STEEL FOR 3IN1 NX	59,50€
	<b>18846</b> RECEPTION RING FOR HOPPER 3IN1	9,00€
	<b>18614</b> FITTING FOR LIMITED ACCESS TO FEED FOR 3IN1 FEEDER, INCL. FASTENING SCREWS	46,00€
	<b>281490</b> PRESS NIPPLE 3IN1 SS 1/2" EXT.TREAD	10,00€
	<b>281496</b> PRESS NIPPLE SS FOR TOM PIPE FEEDER 1/2' EXTERNAL THREAD	6,00€

## Rare spare parts



**281518**

SLIDING ELEMENT FOR 3IN1 NX

2,50€



**72395**

HELIX SMALL

4,00€

## Boxfeeder - Weaners



**560042M**

BOX FEEDERS WEANERS 2X1 SS TROUGH 41,5X74X31 CM ASSEMBLED  
ASSEMBLED FEEDER

161,50€



**560042U**

BOX FEEDERS WEANERS 2X1 SS TROUGH 41,5X74X31 CM UNASSEMBLED  
UNASSEMBLED FEEDER

156,50€



**560043M**

BOX FEEDERS WEANERS 3X1 SS TROUGH 61,5X74X31 CM ASSEMBLED  
ASSEMBLED FEEDER

204,50€



**560043U**

BOX FEEDERS WEANERS 3X1 SS TROUGH 61,5X74X31 CM UNASSEMBLED  
UNASSEMBLED FEEDER

196,00€



**560044M**

BOX FEEDERS WEANERS 4X1 SS TROUGH 81,5X74X31 CM ASSEMBLED  
ASSEMBLED FEEDER

257,00€



**560044U**

BOX FEEDERS WEANERS 4X1 SS TROUGH 81,5X74X31 CM UNASSEMBLED  
UNASSEMBLED FEEDER

245,50€



**560045M**

BOX FEEDERS WEANERS 5X1 SS TROUGH 101,5X74X31 CM ASSEMBLED  
ASSEMBLED FEEDER

301,00€



**560045U**

BOX FEEDERS WEANERS 5X1 SS TROUGH 101,5X74X31 CM UNASSEMBLED  
UNASSEMBLED FEEDER











281,00€



**560046M**













BOX FEEDERS WEANERS 6X1 SS TROUGH 121,5X74X31 CM ASSEMBLED  
ASSEMBLED FEEDER

346,00€

	<b>560046U</b> BOX FEEDERS WEANERS 6X1 SS TROUGH 121,5X74X31 CM UNASSEMBLED UNASSEMBLED FEEDER	327,00€
	<b>560052M</b> BOX FEEDERS WEANERS 2X2 SS TROUGH 41,5X74X62 CM ASSEMBLED ASSEMBLED FEEDER	286,00€
	<b>560052U</b> BOX FEEDERS WEANERS 2X2 SS TROUGH 41,5X74X62 CM UNASSEMBLED UNASSEMBLED FEEDER	264,50€
	<b>560053M</b> BOX FEEDERS WEANERS 3X2 SS TROUGH 61,5X74X62 CM ASSEMBLED ASSEMBLED FEEDER	356,00€
	<b>560053U</b> BOX FEEDERS WEANERS 3X2 SS TROUGH 61,5X74X62 CM UNASSEMBLED UNASSEMBLED FEEDER	330,00€
	<b>560054M</b> BOX FEEDERS WEANERS 4X2 SS TROUGH 81,5X74X62 CM ASSEMBLED ASSEMBLED FEEDER	446,50€
	<b>560054U</b> BOX FEEDERS WEANERS 4X2 SS TROUGH 81,5X74X62 CM UNASSEMBLED UNASSEMBLED FEEDER	411,50€
	<b>560055M</b> BOX FEEDERS WEANERS 5X2 SS TROUGH 101,5X74X62 CM ASSEMBLED ASSEMBLED FEEDER	510,50€
	<b>560055U</b> BOX FEEDERS WEANERS 5X2 SS TROUGH 101,5X74X62 CM UNASSEMBLED UNASSEMBLED FEEDER	467,00€
	<b>560056M</b> BOX FEEDERS WEANERS 6X2 SS TROUGH 121,5X74X62 CM ASSEMBLED ASSEMBLED FEEDER	589,50€
	<b>560056U</b> BOX FEEDERS WEANERS 6X2 SS TROUGH 121,5X74X62 CM UNASSEMBLED UNASSEMBLED FEEDER	546,00€

## Boxfeeder - Finisher

	<b>560062M</b> BOX FEEDERS FINISHER 2X1 SS TROUGH 61,5X99X39 CM ASSEMBLED ASSEMBLED FEEDER	247,50€
---	--	---------

	<b>560062U</b> BOX FEEDERS FINISHER 2X1 SS TROUGH 61,5X99X39 CM UNASSEMBLED UNASSEMBLED FEEDER	232,00€
	<b>560063M</b> BOX FEEDERS FINISHER 3X1 SS TROUGH 91,5X99X39 CM ASSEMBLED ASSEMBLED FEEDER	330,00€
	<b>560063U</b> BOX FEEDERS FINISHER 3X1 SS TROUGH 91,5X99X39 CM UNASSEMBLED UNASSEMBLED FEEDER	308,00€
	<b>560064M</b> BOX FEEDERS FINISHER 4X1 SS TROUGH 120,5X99X39 CM ASSEMBLED ASSEMBLED FEEDER	403,00€
	<b>560064U</b> BOX FEEDERS FINISHER 4X1 SS TROUGH 120,5X99X39 CM UNASSEMBLE UNASSEMBLED FEEDER	392,00€
	<b>560065M</b> BOX FEEDERS FINISHER 5X1 SS TROUGH 151,5X99X39 CM ASSEMBLED ASSEMBLED FEEDER	472,00€
	<b>560065U</b> BOX FEEDERS FINISHER 5X1 SS TROUGH 151,5X99X39 CM UNASSEMBLE UNASSEMBLED FEEDER	451,00€
	<b>560072M</b> BOX FEEDERS FINISHER 2X2 SS TROUGH 61,5X99X80 CM ASSEMBLED ASSEMBLED FEEDER	403,50€
	<b>560072U</b> BOX FEEDERS FINISHER 2X2 SS TROUGH 61,5X99X80 CM UNASSEMBLED UNASSEMBLED FEEDER	386,00€
	<b>560073M</b> BOX FEEDERS FINISHER 3X2 SS TROUGH 91,5X99X80 CM ASSEMBLED ASSEMBLED FEEDER	540,00€
	<b>560073U</b> BOX FEEDERS FINISHER 3X2 SS TROUGH 91,5X99X80 CM UNASSEMBLED UNASSEMBLED FEEDER	510,50€
	<b>560074M</b> BOX FEEDERS FINISHER 4X2 SS TROUGH 120,5X99X80 CM ASSEMBLED ASSEMBLED FEEDER	676,50€
	<b>560074U</b> BOX FEEDERS FINISHER 4X2 SS TROUGH 120,5X99X80 CM UNASSEMBLE UNASSEMBLED FEEDER	632,00€

	<b>560075M</b> BOX FEEDERS FINISHER 5X2 SS TROUGH 151,5X99X80 CM ASSEMBLED ASSEMBLED FEEDER	777,50€
---	---	---------

	<b>560075U</b> BOX FEEDERS FINISHER 5X2 SS TROUGH 151,5X99X80 CM UNASSEMBLE UNASSEMBLED FEEDER	736,00€
---	--	---------

## CCM Feeder

	<b>18746</b> CCM MAXI TYPE II (71 L)) TROU W/DOME, FINISHERS 25-115 KG, 30-40 ANIMALS/FEEDER	1001,50€
---	--	----------

	<b>18090</b> CCM FEEDER MINI 40L WEANER 5-35 KG, 30-40 PER FEEDER, TROUGH Ø50/10CM HIGH	736,00€
---	---	---------

## Downpipe T-Piece

	<b>0227-591</b> FEED DOWNPIPE Ø63X1000 INCLUDING Ø38 T-PIECE ACCESSORIES FOR FEEDERS	10,00€
---	--	--------

	<b>0227-592</b> FEED DOWNPIPE Ø63X1000 INCLUDING Ø60 T-PIECE ACCESSORIES FOR FEEDERS	9,50€
---	--	-------

	<b>0227-593</b> FEED DOWNPIPE Ø63X3000 INCLUDING Ø38 T-PIECE ACCESSORIES FOR FEEDERS	18,00€
---	--	--------

	<b>0227-594</b> FEED DOWNPIPE Ø63X3000 INCLUDING Ø60 T-PIECE ACCESSORIES FOR FEEDERS	17,50€
---	--	--------

	<b>0142-015</b> T-PIECE WITH SLIDE, Ø38 DRYFEEDING PIPE	8,50€
---	---	-------

	<b>0232-010</b> T-PIECE WITH SLIDE, Ø60 ACCESSORIES FOR FEEDING PIPES	8,50€
---	---	-------

	<b>0232-009</b> SLIDE (BLACK) ACCESSORIES FOR FEEDING PIPES	2,50€
---	---	-------



**0232-007**

2,00€

SLIDE FOR T-PIECE  
ACCESSORIES FOR FEEDING PIPES

## Downpipe Solid Piece



**90550**

14,50€

FEED DOWNPIPE 38 MM WITH FIXED T-PIECE  
FEED PIPES



**90552**

15,50€

FEED DOWNPIPE 50 MM WITH FIXED T-PIECE  
FEED PIPES



**90554**

17,00€

FEED DOWNPIPE 60 MM WITH FIXED T-PIECE  
FEED PIPES



**90571**

32,00€

FEED DOWNPIPE 38 MM Y- MODEL WITH FIXED T-PIECE  
FEED PIPES



**90573**

32,50€

FEED DOWNPIPE 50 MM Y-MODEL WITH FIXED T-PIECE  
FEED PIPES



**90574**

34,50€

FEED DOWNPIPE 60 MM Y-MODEL WITH FIXED T-PIECE  
FEED PIPES



**90560**

10,00€

FEED DOWNPIPE 38 MM WITH FIXED T-PIECE FOR TUBE FEEDER  
FEED PIPES



**90562**

10,50€

FEED DOWNPIPE 50 MM WITH FIXED T-PIECE FOR TUBE FEEDER  
FEED PIPES



**90564**

12,50€

FEED DOWNPIPE 60 MM WITH FIXED T-PIECE FOR TUBE FEEDER  
FEED PIPES



**90482**

5,50€

FIXED T-PIECE FOR 38 MM  
ACCESSORIES FOR FEEDING PIPES



**90484**

6,00€

FIXED T-PIECE FOR 50 MM  
ACCESSORIES FOR FEEDING PIPES

	<b>90486</b> FIXED T-PIECE FOR 60 MM ACCESSORIES FOR FEEDING PIPES	8,00€
---	--	-------

### Downpipe Solid Accessories

	<b>0228-595</b> TELESCOP WITH DOWNPIPE	15,00€
---	---	--------

	<b>0228-588</b> DOWNPIPE Ø63X2 1000 MM WITH HOLE DRYFEEDING PIPE	10,00€
---	--	--------

	<b>90268</b> MASTER COLLAR, PLASTIC, FOR DOWN PIPE ACCESSORIES FOR FEEDING PIPES	2,00€
---	--	-------

	<b>90212</b> Y-BRANCH 63 MM 30° ACCESSORIES FOR FEEDING PIPES	10,00€
---	---	--------

### Downpipe Solid Piece - Ø75 MM Outlet

	<b>0228-488</b> FIXED T-PIECE 76 MM ACCESSORIES FOR FEEDING PIPES	10,00€
---	---	--------

	<b>90249</b> PLASTIC DOWN TUBE 75 SPEC. LENGTH	Ask for price
---	---	---------------













	<b>0228-480</b> TELESCOP PIPE Ø80 ACCESSORIES FOR FEEDING PIPES	15,50€
---	---	--------

	<b>0228-510</b> Y-PIECE 75 MM 60° ACCESSORIES FOR FEEDING PIPES	8,00€
---	---	-------











### Water supply





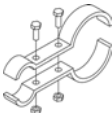
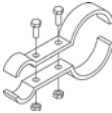







	<b>20000055</b> PVC PIPE W/SOCKET 32 MM, PRICE PER METER, LENGTH 5 METER ACCESSORIES FOR WATER SYSTEM	2,50€
---	---	-------

	<b>23900341</b> PVC SOCKET 32 MM TN16 ACCESSORIES FOR FEEDING PIPES	1,00€
---	---	-------













	<b>23900344</b> PVC SCREW CAP 32 MM ACCESSORIES FOR FEEDING PIPES	1,00€
	<b>23900351</b> PVC THREADED SOCKET 1/2" 32 MM ACCESSORIES FOR FEEDING PIPES	2,50€
	<b>60176</b> 32 MM-3/4 CONNECTOR MUFF/FEMALE THREAD ACCESSORIES FOR FEEDING PIPES	4,50€
	<b>23900343</b> PVC THREADED SOCKET 1" 32 MM ACCESSORIES FOR FEEDING PIPES	1,50€
	<b>60188</b> 32 MM-3/4 CONNECTOR MUFF/MALE THREAD ACCESSORIES FOR FEEDING PIPES	2,50€
	<b>60190</b> 32 MM-1 JOINT/MALE THREAD/CONNECTOR ACCESSORIES FOR FEEDING PIPES	3,50€
	<b>23900345</b> PVC UNION 32 MM ACCESSORIES FOR FEEDING PIPES	3,00€
	<b>23900338</b> PVC ANGLE 90° 32MM TN16 ACCESSORIES FOR FEEDING PIPES	1,00€
	<b>23900340</b> PVC TEE 90° 32 MM TN16 ACCESSORIES FOR FEEDING PIPES	1,50€
	<b>23900347</b> PVC TEE 32 MM X 1/2" X 32 MM ACCESSORIES FOR FEEDING PIPES	2,00€
	<b>23900363</b> PVC CROSS 32MM ACCESSORIES FOR FEEDING PIPES	7,00€
	<b>23900358</b> PVC-BALL VALVE W/ADHESIVE SOCK 32 MM ACCESSORIES FOR FEEDING PIPES	7,00€
	<b>60200</b> 1/2-1/2" JOINT MALE THREAD/MALE THREAD PVC ACCESSORIES FOR FEEDING PIPES	1,50€











	<b>23900299</b> COLLAR NIPPLE PVC NIF 1" ACCESSORIES FOR WATER SYTSTEM	2,50€
	<b>8500532</b> WATERPIPE HOLDER FOR 32 MM PVC PIPES	1,50€
	<b>3900265</b> Ø32 PIPE HANGER ON TOP OF FIBER PLATE	1,50€
	<b>23900386</b> SHIM FOR 32 MM PVC PIPEHANGER	3,50€
	<b>3900084</b> PIPE FITTINGS KIT FOR Ø32 MM PVC-TUBE AGAINST WALL ACCESSORIES FOR FEEDING PIPES	2,00€
	<b>3900095</b> PIPE FITTINGS, KIT Ø32 MM PVCTUBE AGAINST BOARD PROFILE ACCESSORIES FOR FEEDING PIPES	2,00€
	<b>3900086</b> PIPE SUPPORT 5 X 10 CM, COMPLETE ACCESSORIES FOR FEEDING PIPES	4,50€
	<b>3900091</b> TUBE FITTINGS Ø38 X Ø32 MM, COMPLETE ACCESSORIES FOR FEEDING PIPES	4,50€
	<b>3900092</b> TUBE FITTINGS Ø60 X 32 MM, COMPLETE ACCESSORIES FOR FEEDING PIPES	4,50€
	<b>4900945</b> WATER FILTER SET ACCESSORIES FOR WATERSYSTEM	339,00€
	<b>560573</b> FILTER FOR 93775 150 MY ACCESSORIES FOR WATERSYSTEM	73,50€
	<b>4900946</b> WATER GAUGE SET ACCESSORIES FOR WATERSYSTEM	580,00€
	<b>4900950</b> MEDICINE MIXER SET ACCESSORIES FOR WATERSYSTEM	997,50€

	<b>60450</b> SUSPENSION KIT FOR WIRE ACCESSORIES FOR FEEDING PIPES	35,50€
	<b>02900021</b> PIANO WIRE 2,0 MM STAINLESS STEEL, PRICE PER METER WIRE	0,37€
	<b>02900000</b> GALVANIZED SPRING WIRE Ø3,0 MM, PRICE PER METER WIRE	2,00€
	<b>29100001</b> THREAD TAPE 1 ROLL = 10 M ACCESSORIES FOR WATER SYTSTEM	1,50€
	<b>18984</b> LIQUID SEALING 100 ML TUBE ACCESSORIES FOR TUBES	35,00€
	<b>23900112</b> PEVICOL GLUE 0,5 KG ACCESSORIES FOR FEEDING PIPES	33,00€
	<b>3900085</b> PVC GLUE 150 G INCL. CLEANING FLUID ACCESSORIES FOR FEEDING PIPES	39,00€
	<b>76200023</b> CABLE TIE 290 X 4,5 MM BLACK ACCESSORIES FOR WATER SYTSTEM	0,50€
<b>8 MM Aqua speed</b>		
	<b>61012</b> PE-HOSE 8X1,5 MM - PRICE PER. METER ACCESSORIES FOR WATER SYTSTEM	1,00€
	<b>61139</b> FEMALE COUPLER 1/4 X 8 MM	2,50€
	<b>61122</b> MALE COUPLER 1/4/8 MM ACCESSORIES FOR WATER SYTSTEM	2,00€
	<b>61124</b> MALE COUPLER 1/2/8 MM ACCESSORIES FOR WATER SYTSTEM	2,00€

	<b>61140</b> FEMALE COUPLER 3/8 X 8 MM ACCESSORIES FOR WATER SYTSTEM	2,50€
	<b>61148</b> SPEED UNION 8 MM MUFF/FEMALE THREAD ACCESSORIES FOR FEEDERS	3,50€
	<b>61226</b> 8 - 8 - 8 MM SPEED T-CONNECTOR ACCESSORIES FOR WATER SYTSTEM	2,50€
	<b>61171</b> 8 MM CONNECTER 90 GR. AQUASPEED ACCESSORIES FOR WATER SYTSTEM	2,00€
	<b>61050</b> 8 MM IN-LINE FITTINGS ACCESSORIES FOR WATER SYTSTEM	1,50€
	<b>61310</b> 8 MM CROSS ACCESSORIES FOR WATER SYTSTEM	5,00€
	<b>61230</b> 8 MM DIVIDER ACCESSORIES FOR WATER SYTSTEM	2,50€
	<b>61195</b> DRILL CLAMP PVC 8MM-32/33,7 MM ACCESSORIES FOR WATER SYTSTEM	7,00€
	<b>61286</b> STOP VALVE FOR 8 MM HOSES ACCESSORIES FOR WATER SYTSTEM	5,00€
<b>10 MM Aqua speed</b>		
	<b>23900529</b> PE-HOSE 10X1,5 MM - PRICE PER METER ACCESSORIES FOR WATER SYTSTEM	1,00€
	<b>23900523</b> AQUASPEED FITTING 10MMX1/2" OUTSIDE THREAD ACCESSORIES FOR WATER SYTSTEM	2,00€
	<b>23900524</b> AQUASPEED FITTING 10MMX1/4" INSIDE THREAD ACCESSORIES FOR WATER SYTSTEM	2,50€

	<b>23900525</b> AQUASPEED FITTING 10MMX1/2" INSIDE THREAD ACCESSORIES FOR WATER SYTSTEM	2,00€
	<b>23900528</b> AQUASPEED CONNECTOR 10 MM ACCESSORIES FOR WATER SYTSTEM	2,00€
	<b>23900533</b> AQUASPEED Y-PIECE 10 MM ACCESSORIES FOR WATER SYTSTEM	3,00€
	<b>23900526</b> AQUASPEED T-PIECE 10 MM ACCESSORIES FOR WATER SYTSTEM	2,00€
	<b>23900538</b> AQUASPEED REDUCTION SOCKET 10/8 MM ACCESSORIES FOR WATER SYTSTEM	2,00€
	<b>23900534</b> AQUASPEED CONNECTION 10MM(HOSE)X15MM ACCESSORIES FOR WATER SYTSTEM	4,00€
	<b>23961195</b> DRILL CLAMP PVC 10MM-32/33,7 MM ACCESSORIES FOR WATER SYTSTEM	7,00€
	<b>23900537</b> STOP VALVE FOR 10 MM HOSES ACCESSORIES FOR WATER SYTSTEM	5,00€
<b>15 MM Aqua speed</b>		
	<b>23900500</b> PE-HOSE 15X1,5 MM - PRICE PER METER HOSE FOR WATER SYTSTEM	1,00€
	<b>23900502</b> AQUASPEED ANGLE 90° 15 MM ACCESSORIES FOR WATER SYTSTEM	2,50€
	<b>23900503</b> AQUASPEED CONNECTION 15MMX1/2" WITH MALE THREAD ACCESSORIES FOR WATER SYTSTEM	2,50€
	<b>23900504</b> AQUASPEED CONNECTION 15 MM X 1/2" WITH FEMALE THREAD ACCESSORIES FOR WATER SYTSTEM	2,50€

	<b>23900505</b> AQUASPEED END CAP 15 MM ACCESSORIES FOR WATER SYTSTEM	2,00€
	<b>23900506</b> AQUASPEED ANGLE INSERT 90° 15 MM ACCESSORIES FOR WATER SYTSTEM	3,00€
	<b>23900507</b> AQUASPEED CONNECTOR 15 MM ACCESSORIES FOR WATER SYTSTEM	2,50€
	<b>23900508</b> AQUASPEED T-PIECE 15 MM ACCESSORIES FOR WATER SYTSTEM	4,00€
	<b>23900527</b> AQUASPEED T-PIECE 15/10/15 MM ACCESSORIES FOR WATER SYTSTEM	4,50€
	<b>23900509</b> AQUASPEED STOPCOCK 15 MM ACCESSORIES FOR WATER SYTSTEM	8,50€
	<b>23900510</b> PVC TUBE CUTTER	61,00€
	<b>2900460</b> PIPE HANGER 15 MM WITH SCREW AND DOWEL ACCESSORIES FOR WATER SYTSTEM	1,50€

## **ACO FUNKI A/S general terms of sales and delivery**

This price list is valid from the 1st of April 2021 and replaces all previously published price lists. All prices are gross prices excluding VAT and are subject to the following general sales and delivery terms.

ACO FUNKI A/S is not liable for misprints or product and price changes.

The sales and delivery terms stated below are valid unless a written agreement of derogation is signed between ACO FUNKI A/S and Buyer.

### **Drawings and product information**

Drawings, wording in quotes, illustrations, technical specifications and other product information etc. are guiding and without any obligation or liability. ACO FUNKI A/S is not liable for any errors, misinterpretations, notices or laws etc.

Project material (drawings, illustrations, quotes etc.) are the property of ACO FUNKI A/S and can not be handed over to other parties without the written consent of ACO FUNKI A/S. If this requirement is not met, ACO FUNKI A/S reserves the right to invoice its internal costs.

### **Quotes**

Quotes are made subject to prior sale and validity of quotes. Quotes specifically state validity. ACO FUNKI A/S reserves the right to withdraw any quote without any prior notice.

### **Prices**

All prices are excluding VAT and based on all known taxes and material costs at the time of quote submission. ACO FUNKI A/S reserves the right to price regulations due to changes in taxes or material costs.

### **Payment terms**

8 days net. Buyer is not justified to set off any claims in payments without prior written consent of ACO FUNKI A/S. Overdue payments are subject to 1.5% interest per commenced month. ACO FUNKI A/S reserves the right to require a payment guarantee at any time.

### **Handling fee**

Orders amounting to less than 536 Euros are subject to a handling fee of 27 Euros.

### **Delivery terms**

EXW Herring - according to Incoterms 2020. (ACO FUNKI A/S has taken out transport insurance on all deliveries, notwithstanding delivery condition.)

### **Time of delivery**

Our time of delivery is according to agreement between Buyer and ACO FUNKI A/S.

### **Packing materials**

The packaging fees are subject to changes in the daily price, and can be changed without notice. Currently, pallets are invoiced at 23 Euros each, and transport frames 20 Euros each. (Return is not possible due to risk of infection.)

### **Return of goods**

Return goods are only accepted according to prior and specific agreement between Buyer and ACO FUNKI A/S. ACO FUNKI A/S only accepts return of unused, non-damaged standard goods, which have never been installed. Return goods must be in original packing. Return goods will be credited at 80% of the items' net price.

If ACO FUNKI A/S is project liable all excess items after project completion are the property of ACO FUNKI A/S.

## Other terms

### Mounting

Mounting is not included in quotes from ACO FUNKI A/S, unless otherwise clearly stated in the order confirmation. The same applies to all electric/construction and foundation work.

Mounting is only performed at a fixed price if the mounting site is empty, cleaned up and in an already prepared condition. It is the responsibility of the Buyer to place the material closest possible to the mounting site and to ensure an acceptable accessibility of the mounting site, in accordance with the assessment of Service and Mounting department.

If mounting coincides with other on site work performed by third party, mounting is carried out at an hourly payment rate.

ACO FUNKI A/S reserves the right to change the agreed price on projects with fixed mounting price, if the Service and mounting department does not find the mounting site properly prepared. ACO FUNKI A/S also reserves the right to invoice additional time spent on any in vain driving, wages, site cleaning, removal of goods etc.

Self-supporting cast iron, concrete slats and polymer troughs are never included in the mounting prices, except when otherwise specifically stated in the order confirmation.

All water installations end by the end of the row or on the inside of the section, except when otherwise specifically stated in the order confirmation.

When Buyer self is responsible for mounting, all adjustments to the equipment are at own risk (pipes, board profiles etc.) regardless of any acquired supervision from ACO FUNKI A/S.

Self-supporting cast iron

Due to production method fluctuations in dimensions and sizes may occur. As a result, the product may be uneven.

None of these fluctuations are of any significant importance to the product functionality. Cast iron slats are only intended for pigs and should not be exposed to any other strain.

### General information

Colour difference may generally occur in the products, especially products produced of miscellaneous types of PVC/ plastic/fiber material.

The buyer holds the responsibility of storing the purchased goods under a roof so that the goods are not exposed to frost, water and direct sunlight.

Any damage as a result of incorrect storage as well as damage during transport at the place of delivery is the responsibility of the buyer.

All types of water valves are designed for a working pressure of 2.5-3.0 bar. It is the buyer's responsibility to measure and possibly regulate the water pressure.

ACO FUNKI A/S does not accept complaints on water valves used at a working pressure above 3 bar.

When extra deliveries of goods or services are requested due to alleged lacks, ACO FUNKI A/S reserves the right to invoice the goods' value as well as any other additional costs, in case a previous delivery has been made or the alleged lacks are groundless.

ACO FUNKI A/S disclaims complaint liability if any acid has been added to water/feed without prior accept. ACO FUNKI A/S also disclaims liability if the concrete indoor climate, does not meet with the standards of good indoor climate.

The description of goods should only be considered as guiding and is subject to errors. Therefore the component list is valid for the quote. If the component list is not attached to the quote, it is imposed on the Buyer to obtain it.

For all other conditions regarding deliveries excluding installation, NL92 applies, except for the last sentence of point No. 11 as well as points Nos. 13 and 14.



**FUNKI**



[webshop-acofunki.aco.com](http://webshop-acofunki.aco.com)

**ACO FUNKI A/S**

Price list 2022

[www.acofunki.com](http://www.acofunki.com)  
+45 97 11 96 00  
[acofunki@acofunki.dk](mailto:acofunki@acofunki.dk)

Kirkevænget 5  
7400 Herning  
Denmark

*ACO FUNKI specializes in developing and producing modern pig housing equipment for the pig producers worldwide.*

