

MOUNTING INSTRUCTION

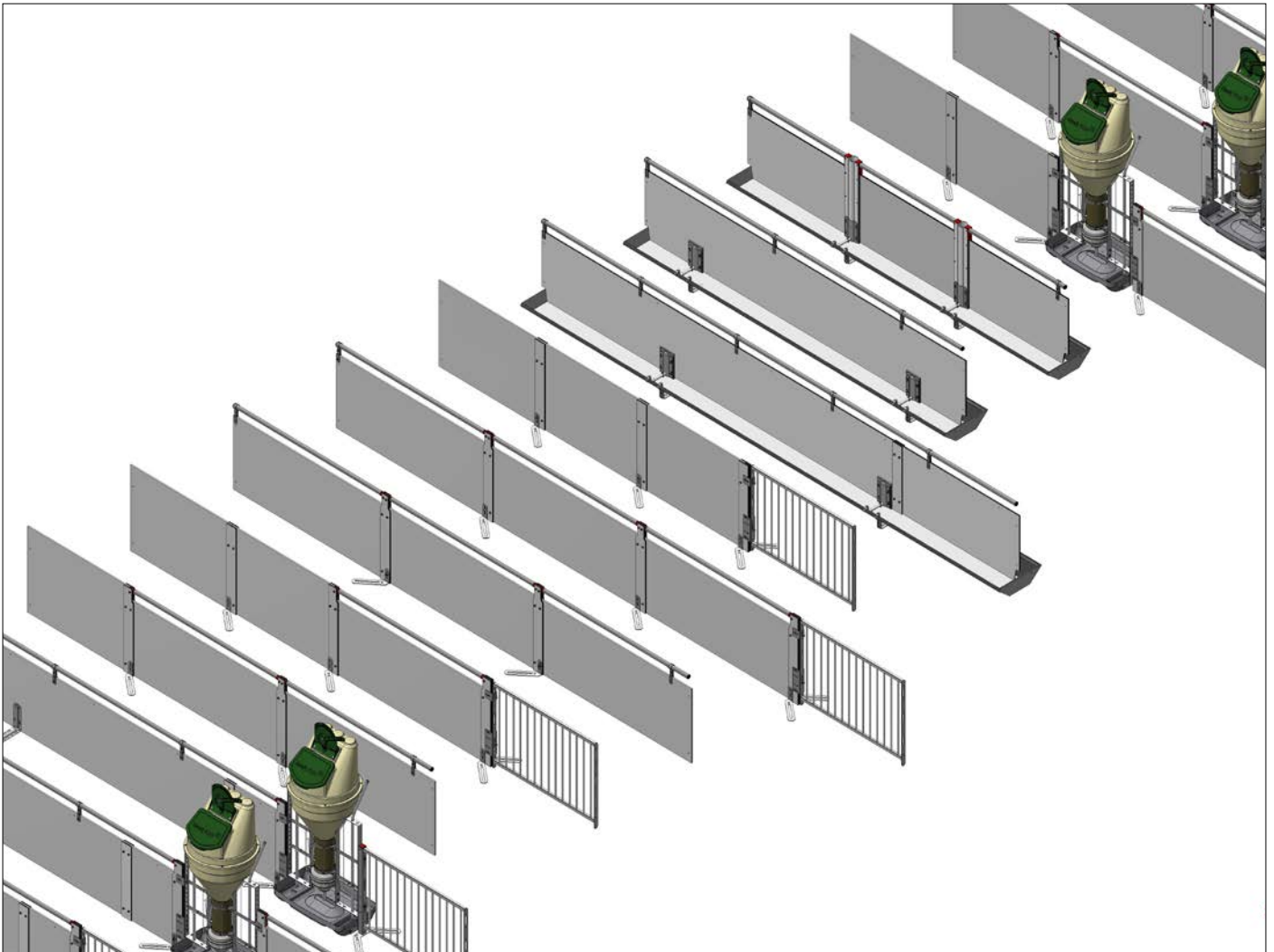

FUNKI FIBER 750 mm



ACO FUNKI A/S
Kirkevænget 5
DK-7400 Herning

Tel. +45 9711 9600
www.acofunki.com
www.egebjerg.com

FUNKI

Fiber_750_01

NOTE:

- Plate length: max 4100 mm
(The plate length should be near 4100 mm to avoid waste)
- Distance between foundation sets: max 2000 mm
(If the distance exceeds 2000 mm, a support foundation is mounted)
- Grille against feeder: see Table 1 below

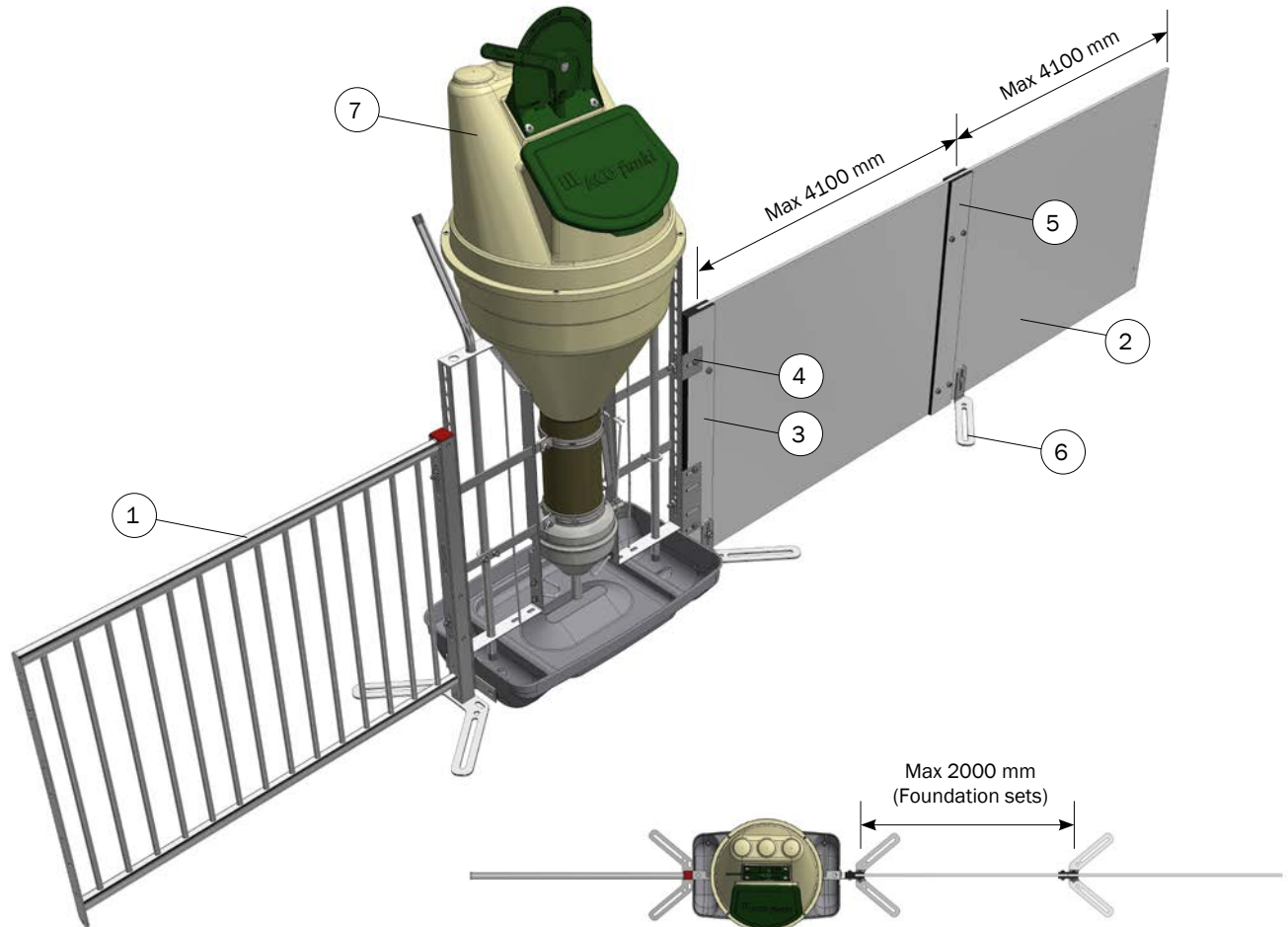

TABLE 1 - GRILLE AGAINST FEEDER

Height, mm	L = 1040 mm	L = 1260 mm	L = 1540 mm
995	4200104	4200126	4200154
870	4400104	4400126	4400154
745	3200104	3200126	3200154

BILL OF MATERIALS

	Item no.	Description	Pcs.
		<i>FIBER_750_01</i>	
1	3200104	GRILLE FOR CLEAN-O-FLEX 750/1040 WITH POST	1
2	4360475-LENGTH	SIDE H75 PLATE	2
3	4300442	POST PLATE H75 FULL HIGH FOR FEEDER	1
4	38524	MOUNTING KIT FOR U-POST AGAINST FEEDERS	1
5	4300433	POST KIT H75	1
6	4500655	LOOSE FOUNDATION SET, LEFT AND RIGHT FOR BOARD PROFILE	2
7	560710M	FUNKIMAT WEANER WITH STAINLESS STEEL TROUGH (FLAT-FLAT)	1

Fiber_750_02

NOTE:

- Plate length: max 4100 mm
(The plate length should be near 4100 mm to avoid waste)
- Distance between foundation sets: max 2000 mm
(If the distance exceeds 2000 mm, a support foundation is mounted)
- Bar length: max 6000 mm
(Stiffening bracket per max 1400 mm)
- Grille against feeder: see Table 1 below

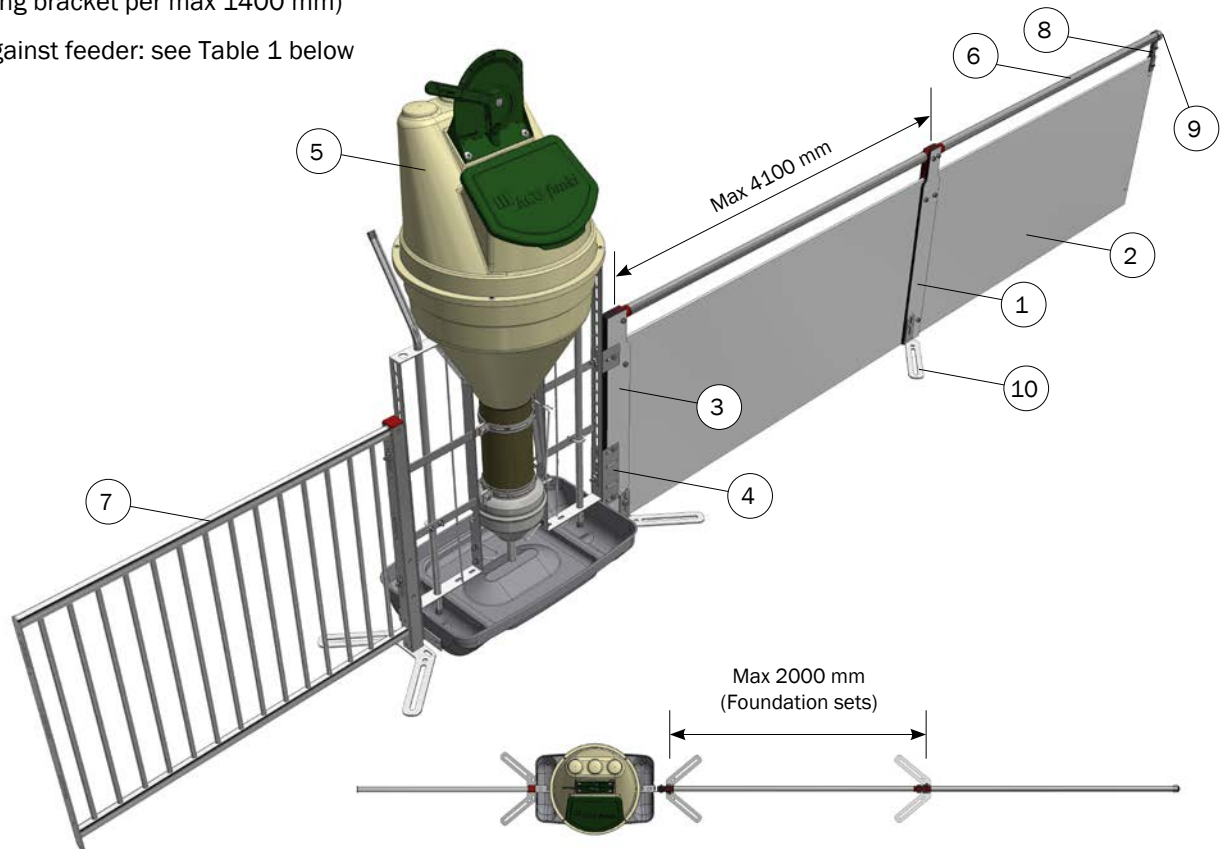

TABLE 1 - GRILLE AGAINST FEEDER

Height, mm	L = 1040 mm	L = 1260 mm	L = 1540 mm
995	4200104	4200126	4200154
870	4400104	4400126	4400154
745	3200104	3200126	3200154

BILL OF MATERIALS

	Item no.	Description	Pcs.
		<i>FIBER_750_02</i>	
1	4300438	POST KIT H75 FOR 1 BAR/PLATE	1
2	4560647	SIDE H64,2 PLATE MAX. LENGTH 4100 MM	2
3	4300445	POST PLATE H75 1 BAR/PLATE FOR FEEDER	1
4	38524	MOUNTING KIT FOR U-POST AGAINST FEEDERS	1
5	560710M	FUNKIMAT WEANER WITH STAINLESS STEEL TROUGH (FLAT-FLAT)	1
6	4310410	1 BAR 1' GALVANIZED, PRICE PER METER	2
7	3200104	GRILLE FOR CLEAN-O-FLEX 750/1040 WITH POST	1
8	4300481	1 PCS STIFFENING BRACKET SET FOR 1 BAR ON PLATE	1
9	9960006	ROUND CAP BLACK (1' PIPE)	1
10	4500655	LOOSE FOUNDATION SET, LEFT AND RIGHT, FOR BOARD PROFILE	2

Fiber_750_03

NOTE:

- Plate length: max 4100 mm
(The plate length should be near 4100 mm to avoid waste)
- Distance between foundation sets: max 2000 mm
(If the distance exceeds 2000 mm, a support foundation is mounted)
- Bar length: max 6000 mm
(Stiffening bracket per max 1400 mm)

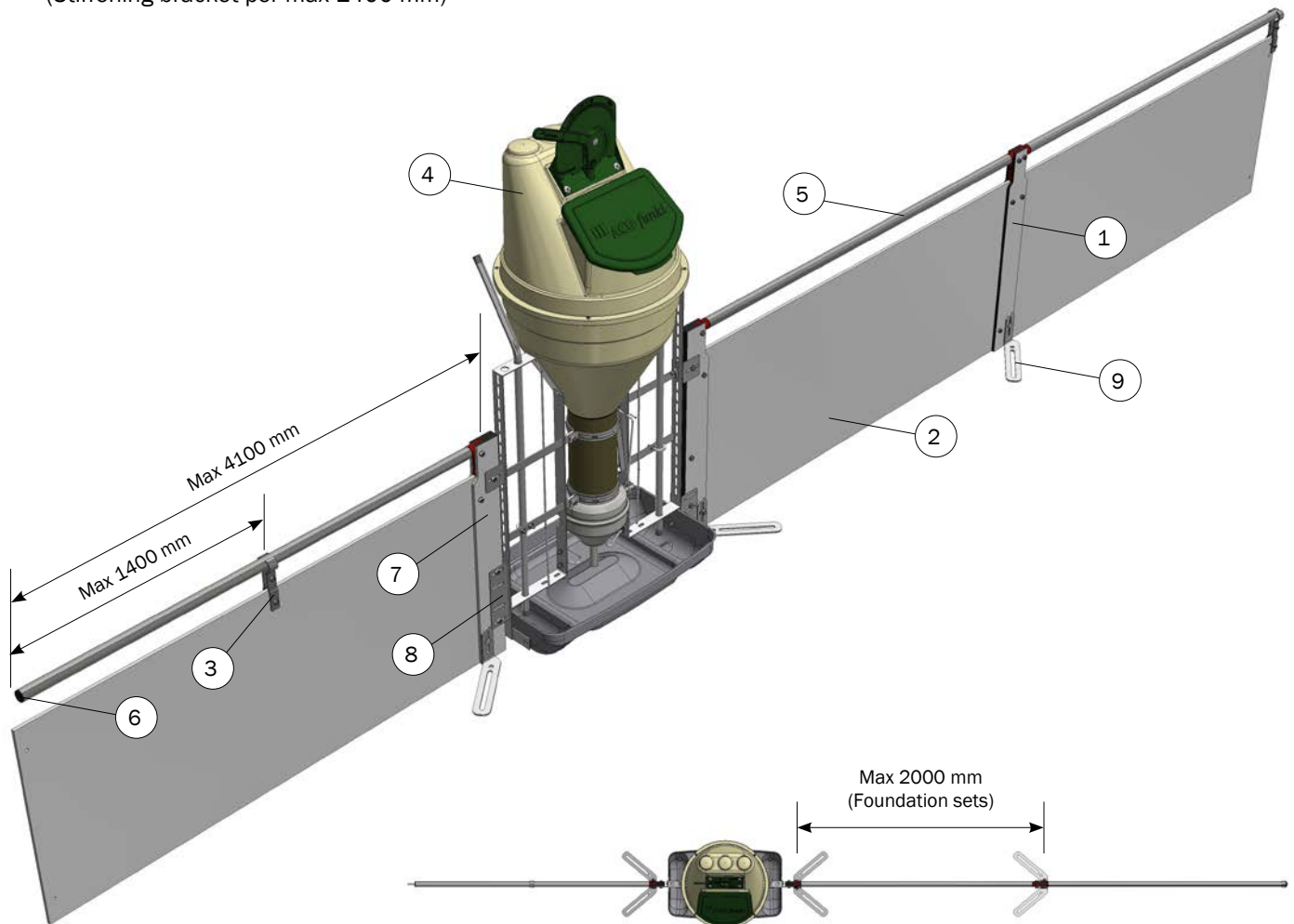

BILL OF MATERIALS

	Item no.	Description	Pcs.
		<i>FIBER_750_03</i>	
1	4300438	POST KIT H75 FOR 1 BAR/PLATE	1
2	4560647	SIDE H64,2 PLATE MAX. LENGTH 4100 MM	3
3	4300482	2 PCS STIFFENING BRACKET SET FOR 1 BAR ON PLATE	2
4	560710M	FUNKIMAT WEANER WITH STAINLESS STEEL TROUGH (FLAT-FLAT)	1
5	4310410	1 BAR 1' GALVANIZED, PRICE PER METER	1
6	9960006	ROUND CAP BLACK (1' PIPE)	3
7	4300445	POST PLATE H75 1 BAR/PLATE FOR FEEDER	2
8	38524	MOUNTING KIT FOR U-POST AGAINST FEEDERS	2
9	4500655	LOOSE FOUNDATION SET, LEFT AND RIGHT, FOR BOARD PROFILE	3

Fiber_750_04

NOTE:

- Plate length: max 4100 mm
(The plate length should be near 4100 mm to avoid waste)
- Distance between foundation sets: max 2000 mm
(If the distance exceeds 2000 mm, a support foundation is mounted)
- Bar length: max 6000 mm
(Stiffening bracket per max 1400 mm)
- Grille against feeder: see Table 1 below

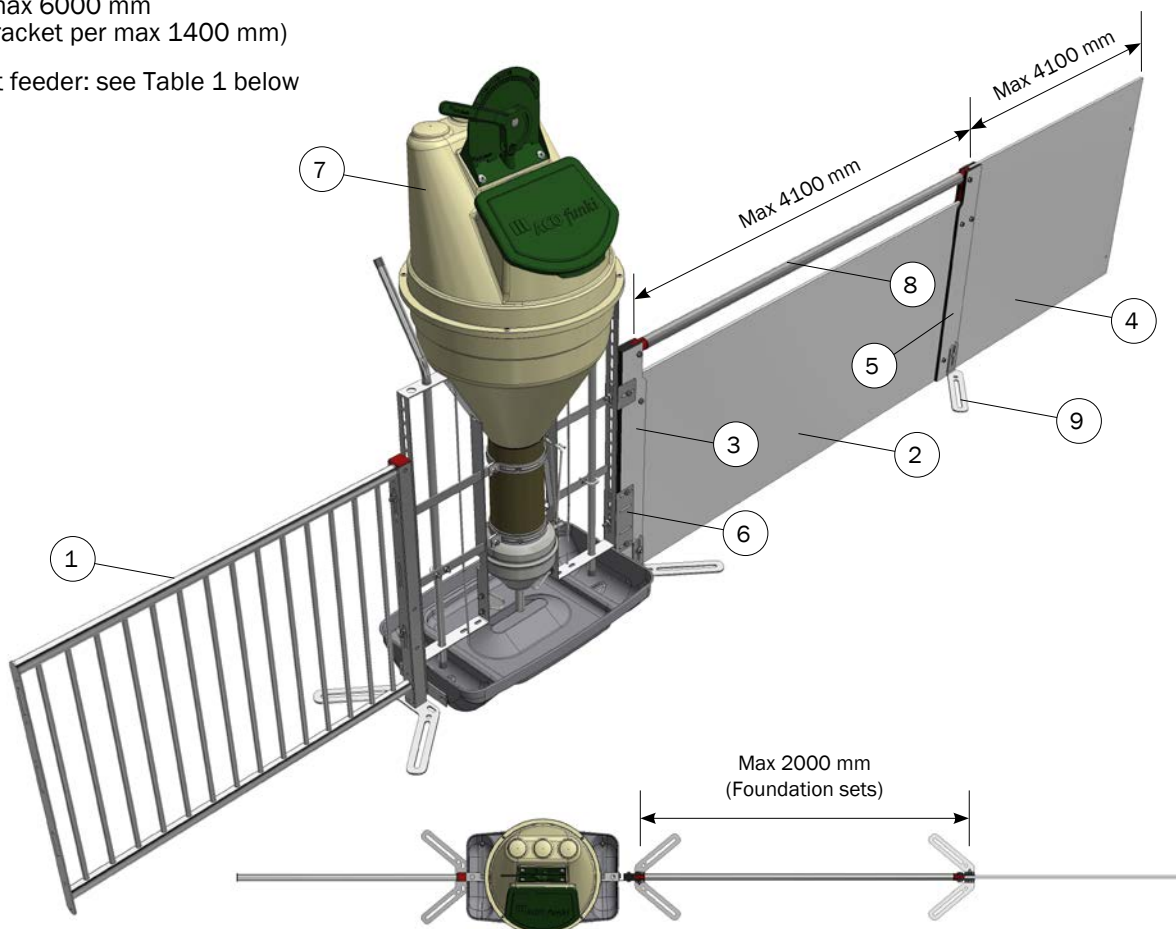

TABLE 1 - GRILLE AGAINST FEEDER

Height, mm	L = 1040 mm	L = 1260 mm	L = 1540 mm
995	4200104	4200126	4200154
870	4400104	4400126	4400154
745	3200104	3200126	3200154

BILL OF MATERIALS

	Item no.	Description	Pcs.
		<i>FIBER_750_04</i>	
1	3200104	GRILLE FOR CLEAN-O-FLEX 750/1040 WITH POST	1
2	4560647	SIDE H64,2 PLATE MAX. LENGTH 4100 MM	1
3	4300445	POST PLATE H75 1 BAR/PLATE FOR FEEDER	1
4	4360475	SIDE H75 PLATE	1
5	4300440	POST KIT H75 COMBI PLATE/BAR	1
6	38524	MOUNTING KIT FOR U-POST AGAINST FEEDERS	1
7	560710M	FUNKIMAT WEANER WITH STAINLESS STEEL TROUGH (FLAT-FLAT)	1
8	4310410	1 BAR 1' GALVANIZED, PRICE PER METER	2

Fiber_750_05

NOTE:

- Plate length: max 4100 mm
(The plate length should be near 4100 mm to avoid waste)
- Distance between foundation sets: max 2000 mm
(If the distance exceeds 2000 mm, a support foundation is mounted)
- Bar length: max 6000 mm
(Stiffening bracket per max 1400 mm)

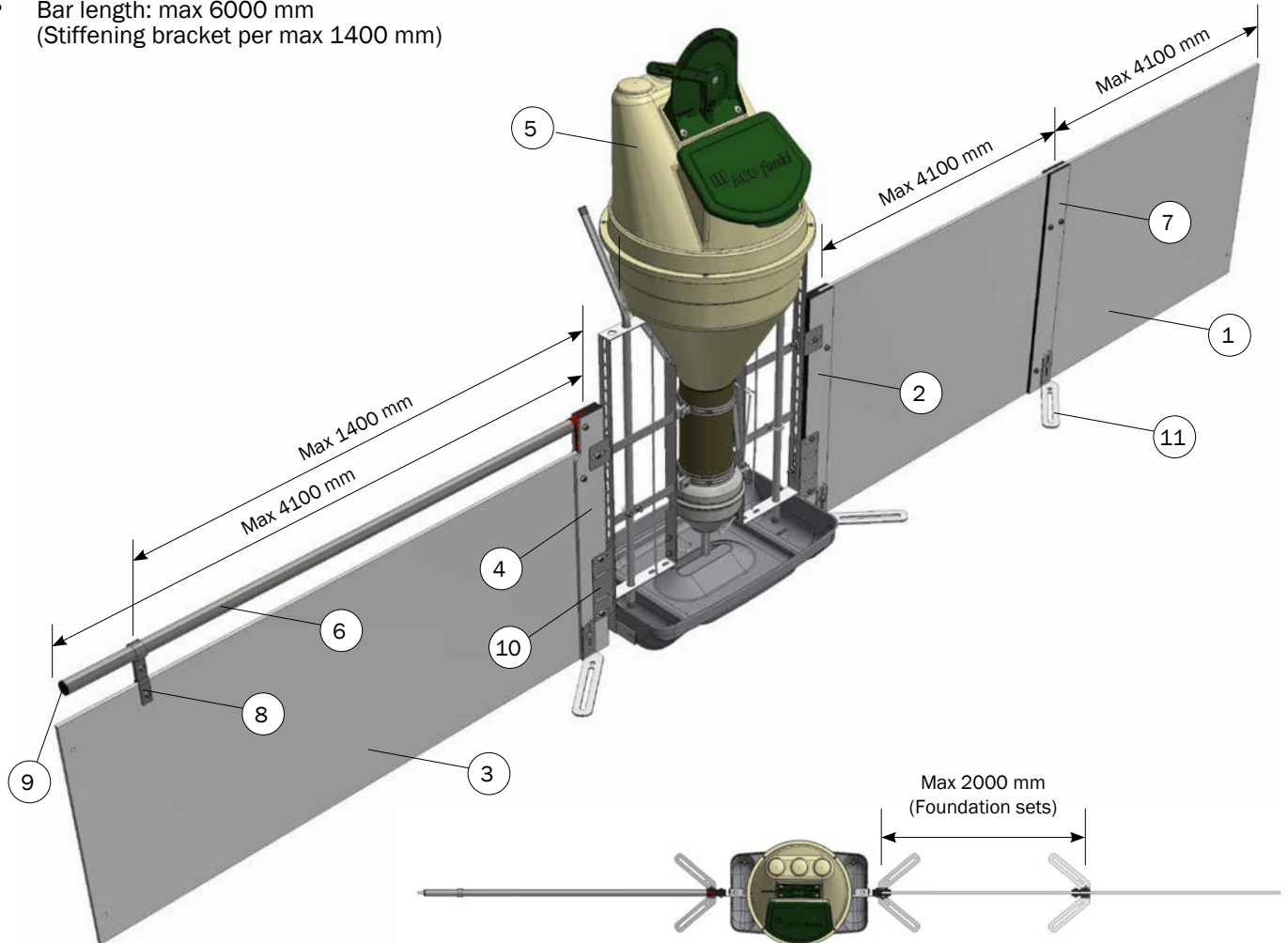

BILL OF MATERIALS

	Item no.	Description	Pcs.
		<i>FIBER_750_05</i>	
1	4360475	SIDE H75 PLATE	1
2	4300442	POST PLATE H75 FULL HIGH FOR FEEDER	1
3	4560647	SIDE H64,2 PLATE MAX. LENGTH 4100 MM	1
4	4300445	POST PLATE H75 1 BAR/PLATE FOR FEEDER	2
5	560710M	FUNKIMAT WEANER WITH STAINLESS STEEL TROUGH (FLAT-FLAT)	1
6	4310410	1 BAR 1' GALVANIZED, PRICE PER METER	1
7	4300433	POST KIT H75	1
8	4300481	1 PCS STIFFENING BRACKET SET FOR 1 BAR ON PLATE	2
9	9960006	ROUND CAP BLACK (1' PIPE)	1
10	38524	MOUNTING KIT FOR U-POST AGAINST FEEDERS	1
11	4500655	LOOSE FOUNDATION SET, LEFT AND RIGHT, FOR BOARD PROFILE	3

Fiber_750_06

NOTE:

- Plate length, plate with integrated downpipe: max 2000 mm
- Bar length: max 6000 mm
(Stiffening bracket per max 1400 mm)
- Distance between foot bracket sets for trough: max 2000 mm

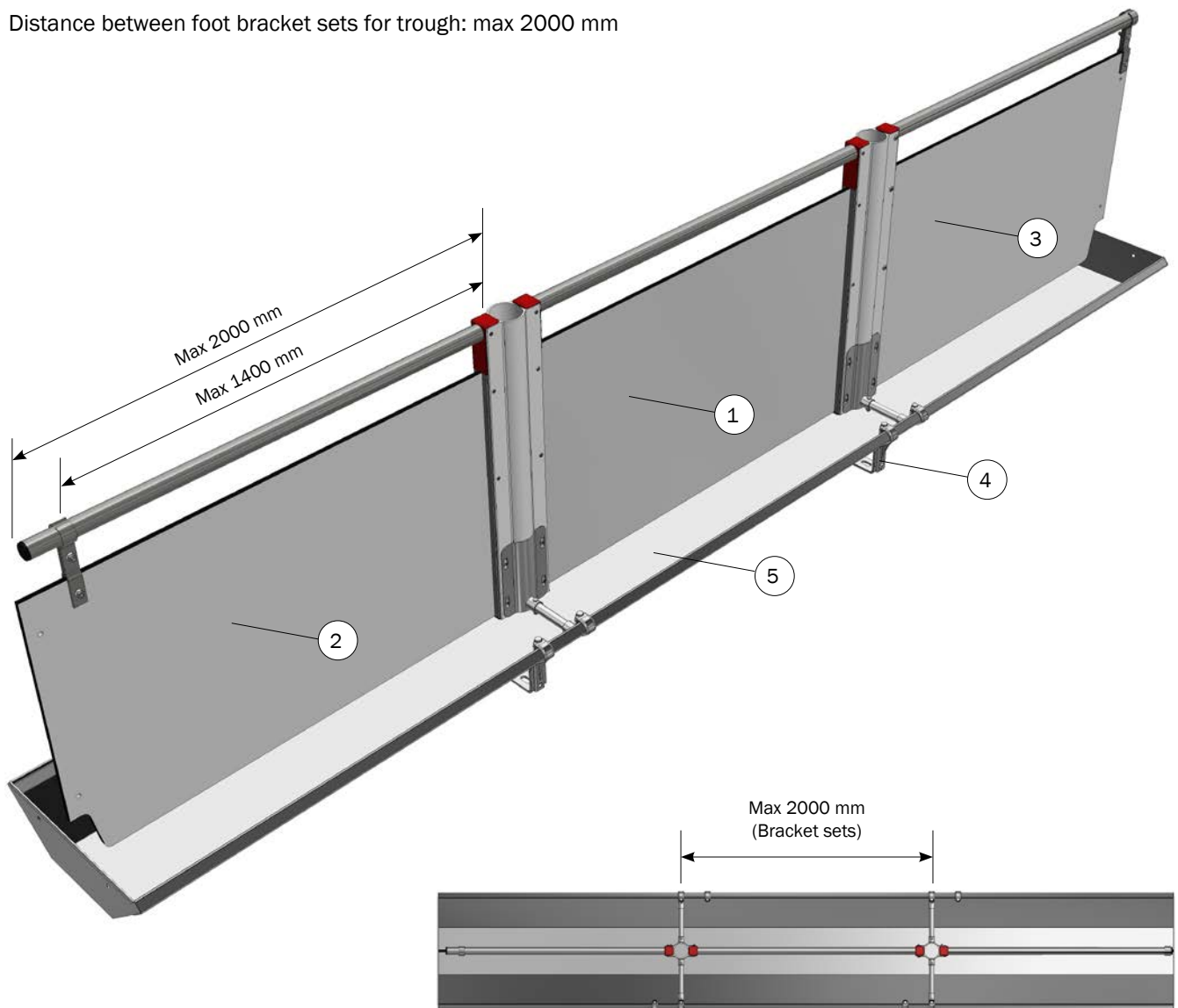

BILL OF MATERIALS			
	Item no.	Description	Pcs.
		<i>FIBER_750_06</i>	
1	4310463	LIQUID FEEDING WALL H75 PLATE/1 BAR, CENTER PIECE	1
2	4310462	LIQUID FEEDING WALL H75 PLATE/1 BAR AGAINST FRONT, DOWNPIPE	1
3	4310461	LIQUID FEEDING WALL H75 PLATE/1 BARS AGAINST WALL, DOWNPIPE	1
4	31002	FOOT BRACKET SET FOR DOUBLE TROUGH, BOARD PROFILE WEANER	1
5	39215	LIQUID FEEDING DOUBLE TROUGH, WEANERS	1

Fiber_750_07

NOTE:

- Plate length: max 4100 mm
(The plate length should be near 4100 mm to avoid waste)
- Bar length: max 6000 mm
(Stiffening bracket per max 1400 mm)
- Distance between foot bracket sets for trough: max 2000 mm

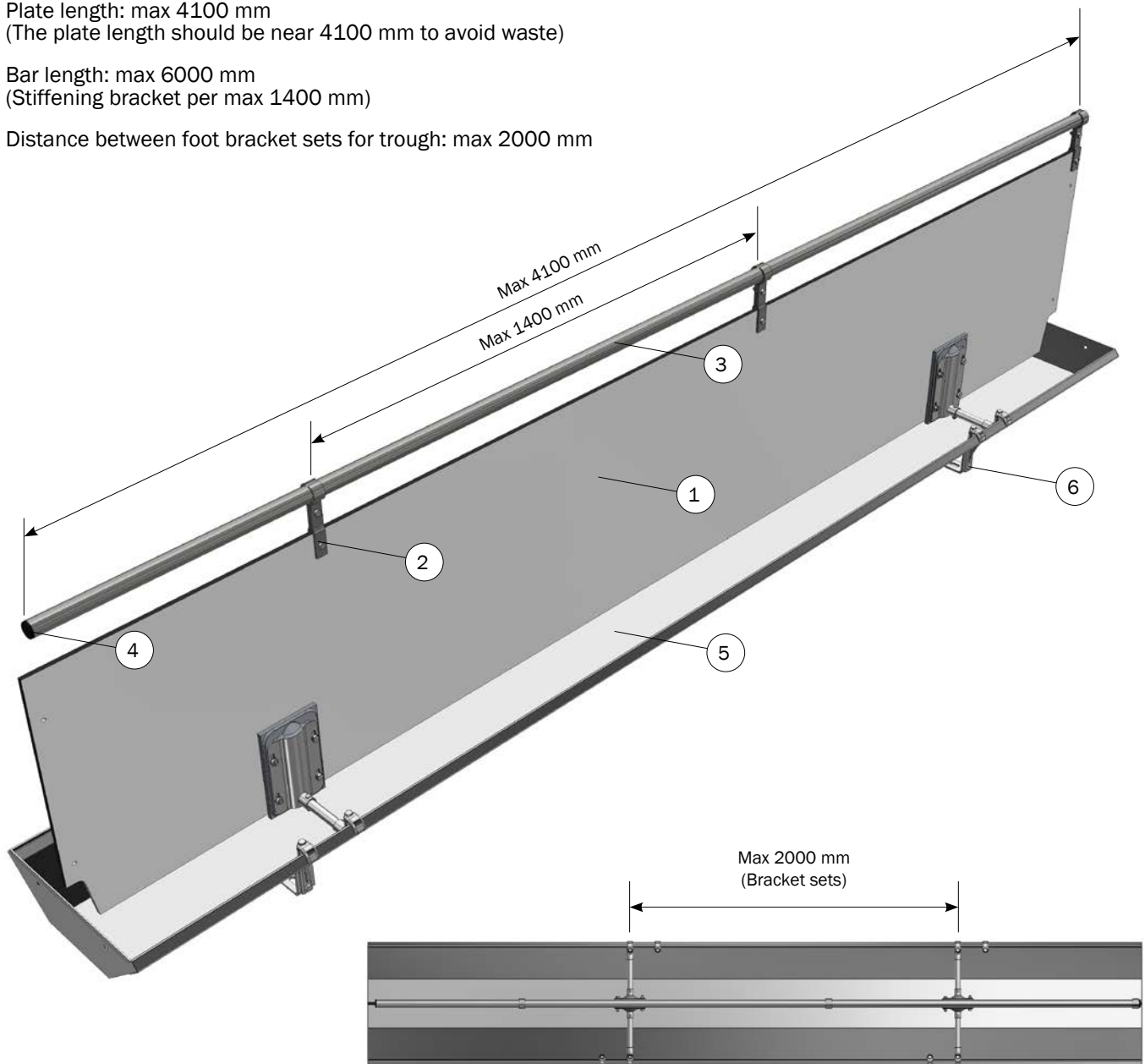

BILL OF MATERIALS			
	Item no.	Description	Pcs.
		<i>FIBER_750_07</i>	
1	4560639	PLATE H57 FOR LIQUID FEEDING WALL WITHOUT DOWNPIPE MAX. LENGTH 4100 MM	1
2	4300483	3 PCS STIFFENING BRACKET SET FOR 1 BAR ON PLATE	1
3	4310410	1 BAR 1' GALVANIZED, PRICE PER METER	1
4	9960006	ROUND CAP BLACK (1' PIPE)	1
5	39215	LIQUID FEEDING DOUBLE TROUGH, WEANERS	1
6	4500344	MOUNTING KIT H85-H96 FOR COMP-O-WALL	1

Fiber_750_08

NOTE:

- Plate length: max 4100 mm
(The plate length should be near 4100 mm to avoid waste)
- Bar length: max 6000 mm
(Stiffening bracket per max 1400 mm)
- Distance between foot bracket sets for trough: max 2000 mm

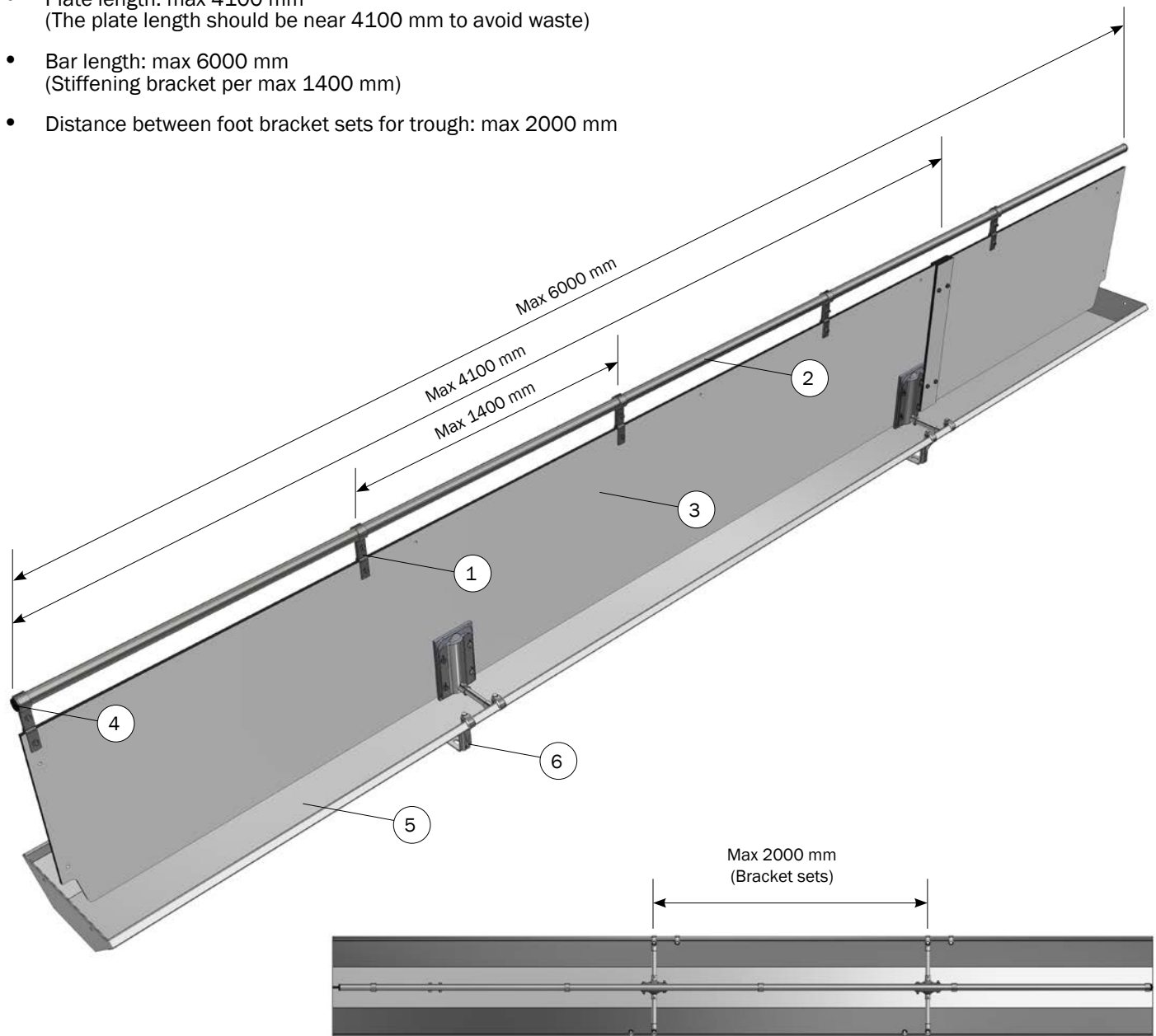

BILL OF MATERIALS

	Item no.	Description	Pcs.
		<i>FIBER_750_08</i>	
1	4300485	5 PCS STIFFENING BRACKET SET FOR 1 BAR ON PLATE	1
2	4310410	1 BAR 1' GALVANIZED, PRICE PER METER	1
3	4510640	PLATE H57 FOR LIQUID FEEDING WALL WITHOUT DOWNPIPE, LENGHT 4100-6000 MM	1
4	9960006	ROUND CAP BLACK (1' PIPE)	2
5	39215	LIQUID FEEDING DOUBLE TROUGH, WEANERS	1
6	4500344	MOUNTING KIT H85-H96 FOR COMP-O-WALL	1

Fiber_750_09

NOTE:

- Plate length: max 4100 mm
(The plate length should be near 4100 mm to avoid waste)
- Distance between foundation sets: max 2000 mm
(If the distance exceeds 2000 mm, a support foundation is mounted)
- Grille against plate: see Table 2 below

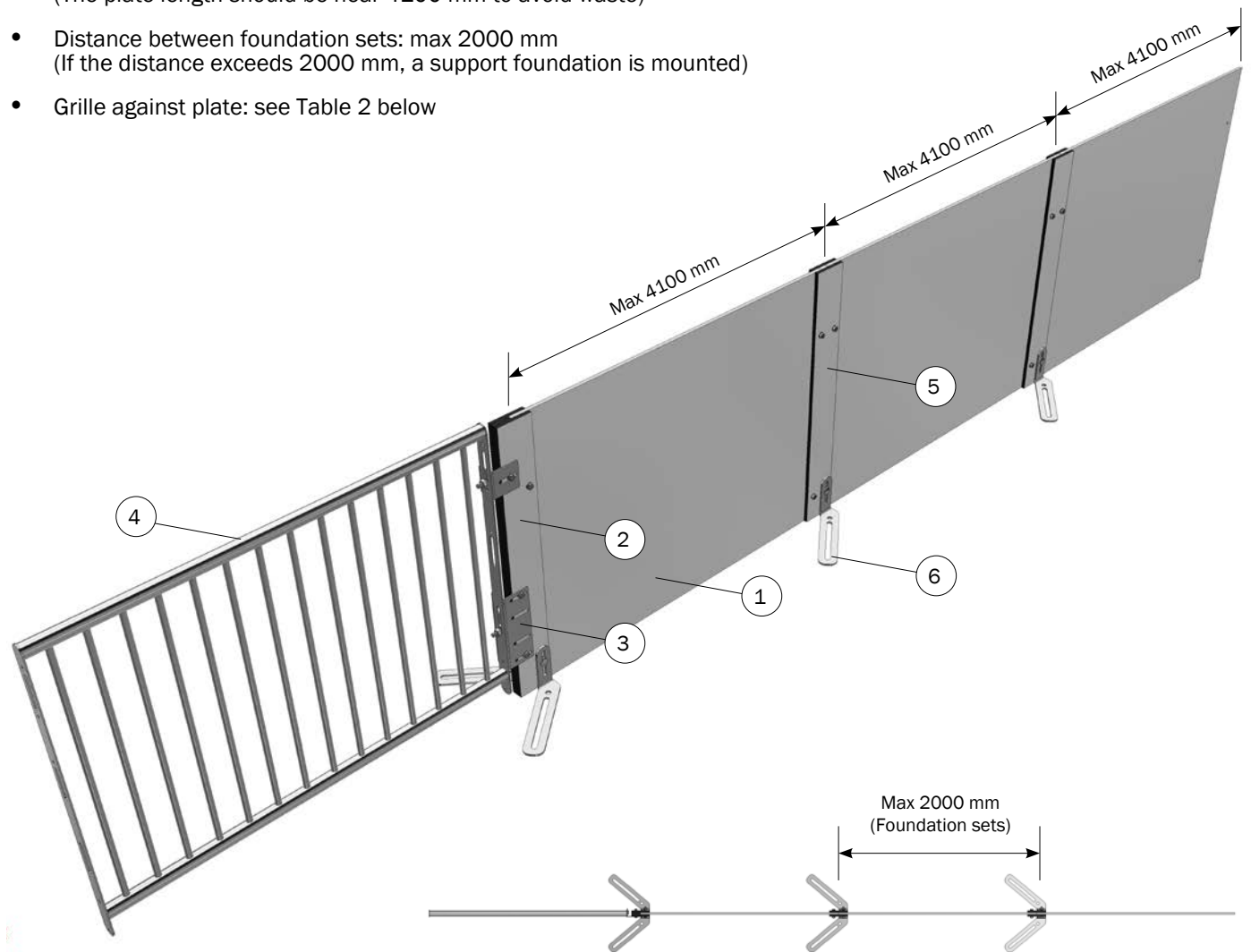

TABLE 2 - GRILLE AGAINST PLATE

Height, mm	L = 1040 mm	L = 1260 mm	L = 1540 mm
995	4150873	4150874	4150875
870	4450873	4450874	4450875
745	3150873	3150874	3150875

BILL OF MATERIALS

	Item no.	Description	Pcs.
		<i>FIBER_750_09</i>	
1	4360475	SIDE H75 PLATE	3
2	4300442	POST PLATE H75 FULL HIGH FOR FEEDER	1
3	38524	MOUNTING KIT FOR U-POST AGAINST FEEDERS	1
4	3150873	STAINLESS STEEL CONTACT GRILLE H:750 L:1000	1
5	4300433	POST KIT H75	2
6	4500655	LOOSE FOUNDATION SET, LEFT AND RIGHT, FOR BOARD PROFILE	3

Fiber_750_10

NOTE:

- Plate length: max 4100 mm
(The plate length should be near 4100 mm to avoid waste)
- Bar length: max 6000 mm
(Stiffening bracket per max 1400 mm)
- Distance between foundation sets: max 2000 mm
(If the distance exceeds 2000 mm, a support foundation is mounted)
- Grille against plate: see Table 2 below

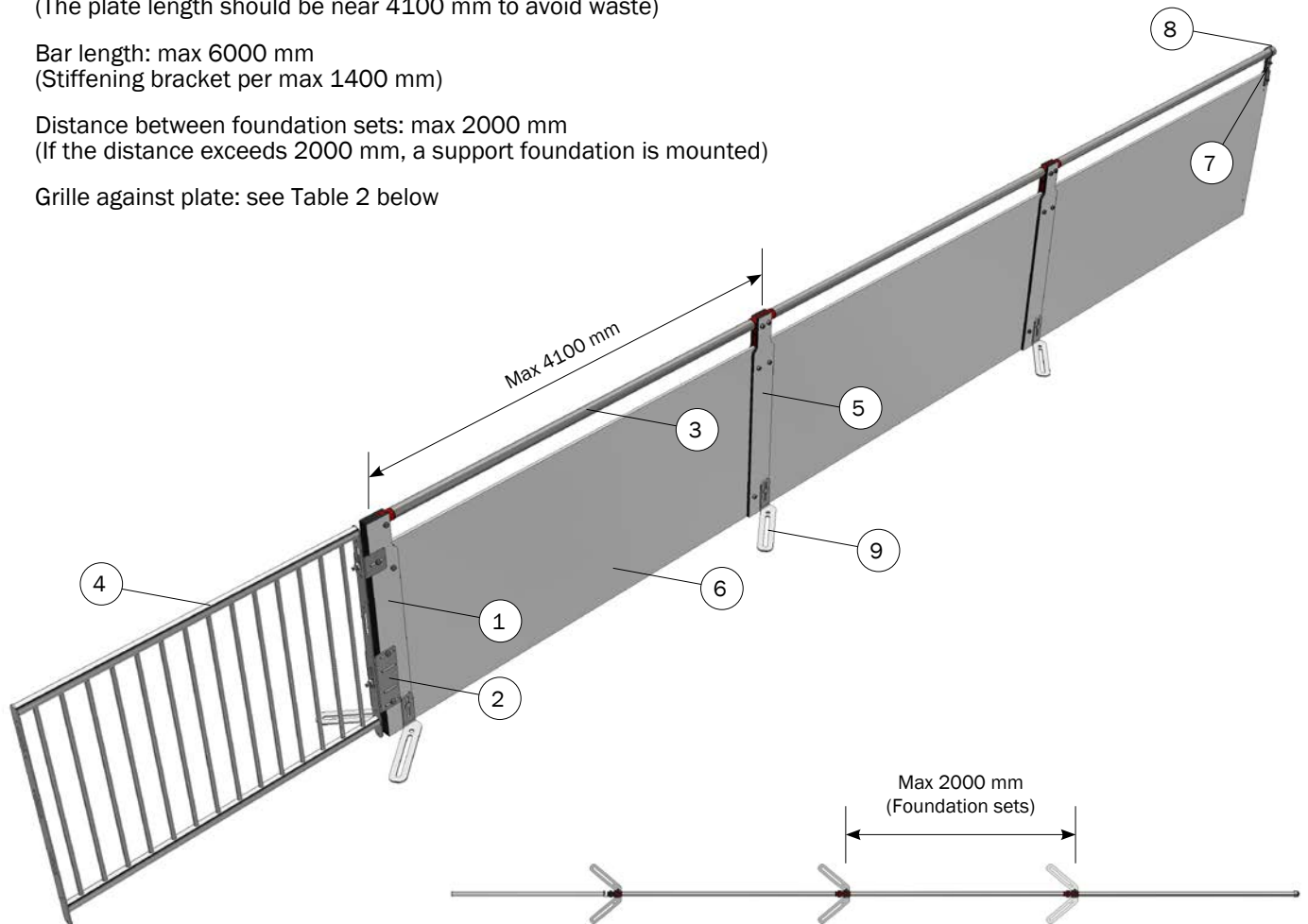

TABLE 2 - GRILLE AGAINST PLATE

Height, mm	L = 1040 mm	L = 1260 mm	L = 1540 mm
995	4150873	4150874	4150875
870	4450873	4450874	4450875
745	3150873	3150874	3150875

BILL OF MATERIALS

	Item no.	Description	Pcs.
		<i>FIBER_750_10</i>	
1	4300445	POST PLATE H75 1 BAR/PLATE FOR FEEDER	1
2	38524	MOUNTING KIT FOR U-POST AGAINST FEEDERS	1
3	4310410	1 BAR 1' GALVANIZED, PRICE PER METER	1
4	3150873	STAINLESS STEEL CONTACT GRILLE H:750 L:1000	1
5	4300438	POST KIT H75 FOR 1 BAR/PLATE	2
6	4560647	SIDE H64,2 PLATE MAX. LENGTH 4100 MM	3
7	4300481	1 PCS STIFFENING BRACKET SET FOR 1 BAR ON PLATE	1
8	9960006	ROUND CAP BLACK (1' PIPE)	1
9	4500655	LOOSE FOUNDATION SET, LEFT AND RIGHT, FOR BOARD PROFILE	3

Fiber_750_11

NOTE:

- Plate length: max 4100 mm
(The plate length should be near 4100 mm to avoid waste)
- Bar length: max 6000 mm
(Stiffening bracket per max 1400 mm)
- Distance between foundation sets: max 2000 mm
(If the distance exceeds 2000 mm, a support foundation is mounted)

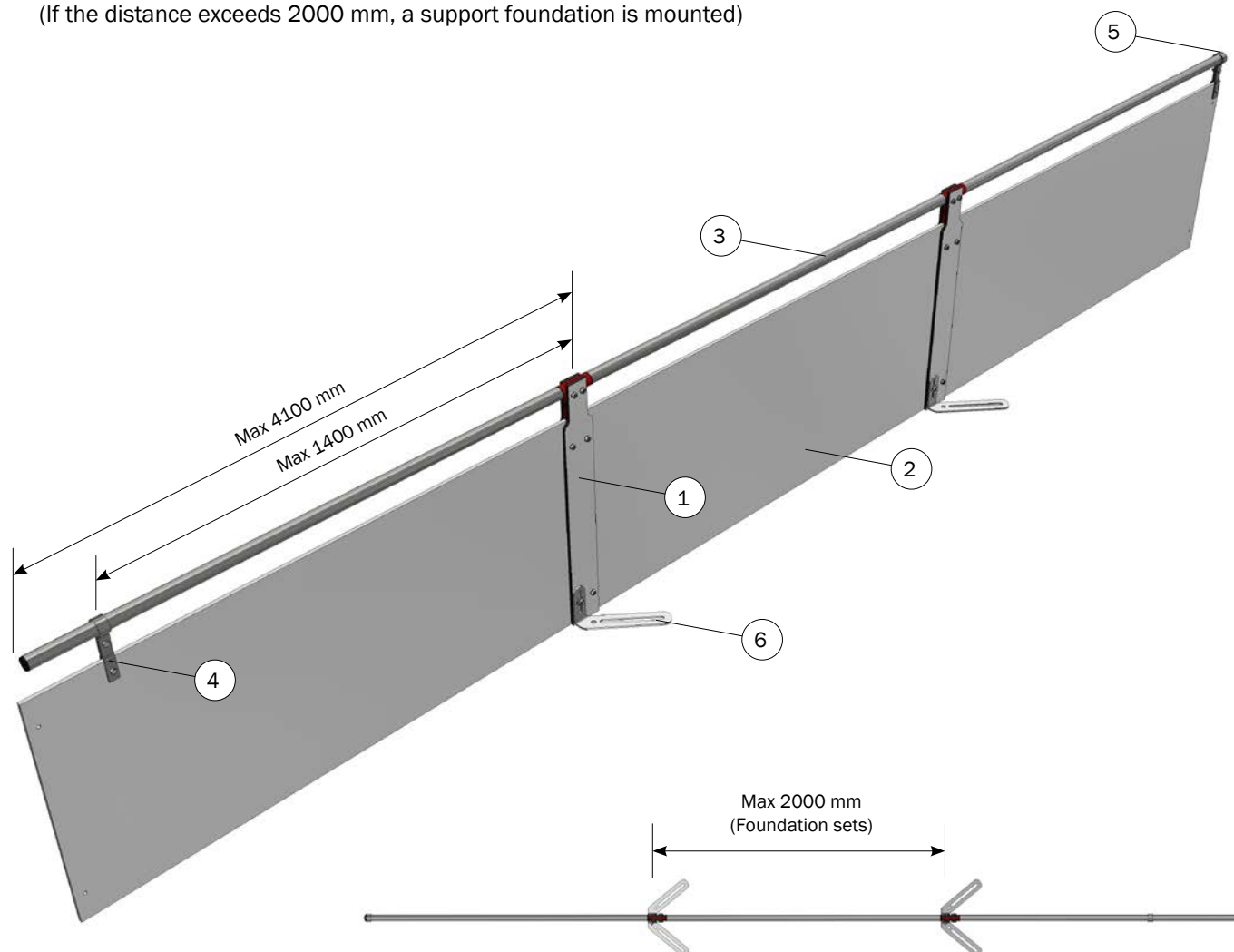

BILL OF MATERIALS

	Item no.	Description	Pcs.
		<i>FIBER_750_11</i>	
1	4300438	POST KIT H75 FOR 1 BAR/PLATE	2
2	4560647	SIDE H64,2 PLATE MAX. LENGTH 4100 MM	3
3	4310410	1 BAR 1' GALVANIZED, PRICE PER METER	1
4	4300482	2 PCS STIFFENING BRACKET SET FOR 1 BAR ON PLATE	3
5	9960006	ROUND CAP BLACK (1' PIPE)	2
6	4500655	LOOSE FOUNDATION SET, LEFT AND RIGHT, FOR BOARD PROFILE	2

Fiber_750_12

NOTE:

- Plate length: max 4100 mm
(The plate length should be near 4100 mm to avoid waste)
- Bar length: max 6000 mm
(Stiffening bracket per max 1400 mm)
- Distance between foundation sets: max 2000 mm
(If the distance exceeds 2000 mm, a support foundation is mounted)
- Grille against plate: see Table 2 below

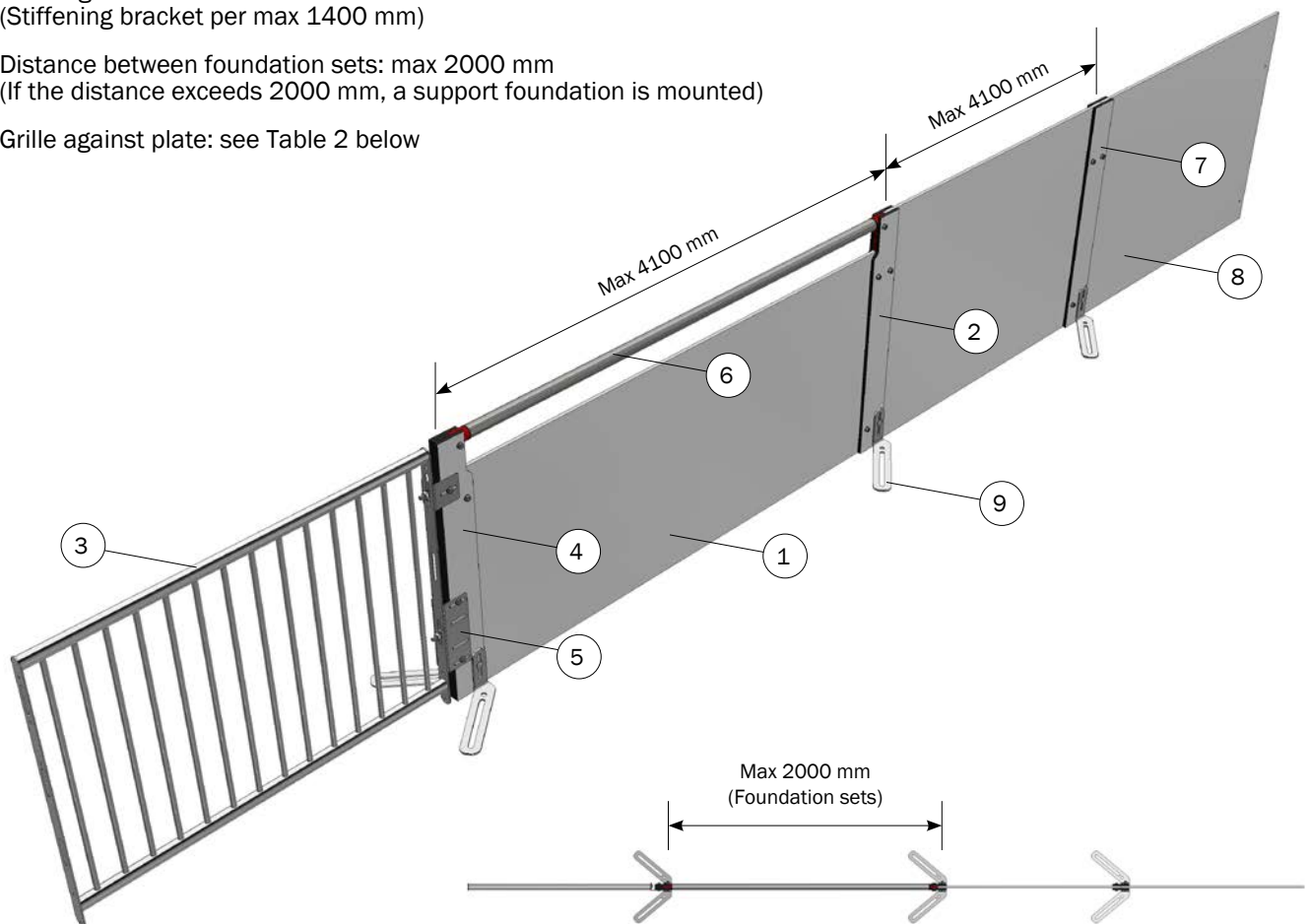

TABLE 2 - GRILLE AGAINST PLATE

Height, mm	L = 1040 mm	L = 1260 mm	L = 1540 mm
995	4150873	4150874	4150875
870	4450873	4450874	4450875
745	3150873	3150874	3150875

BILL OF MATERIALS

	Item no.	Description	Pcs.
		<i>FIBER_750_12</i>	
1	4560647	SIDE H64,2 PLATE MAX. LENGTH 4100 MM	1
2	4300440	POST KIT H75 COMBI PLATE/BAR	1
3	3150873	STAINLESS STEEL CONTACT GRILLE H:750 L:1000	1
4	4300445	POST PLATE H75 1 BAR/PLATE FOR FEEDER	1
5	38524	MOUNTING KIT FOR U-POST AGAINST FEEDERS	1
6	4310410	1 BAR 1' GALVANIZED, PRICE PER METER	1
7	4300433	POST KIT H75	1
8	4360475	SIDE H75 PLATE	2
9	4500655	LOOSE FOUNDATION SET, LEFT AND RIGHT, FOR BOARD PROFILE	3

Fiber_750_13

NOTE:

- Plate length: max 4100 mm
(The plate length should be near 4100 mm to avoid waste)
- Bar length: max 6000 mm
(Stiffening bracket per max 1400 mm)
- Distance between foundation sets: max 2000 mm
(If the distance exceeds 2000 mm, a support foundation is mounted)

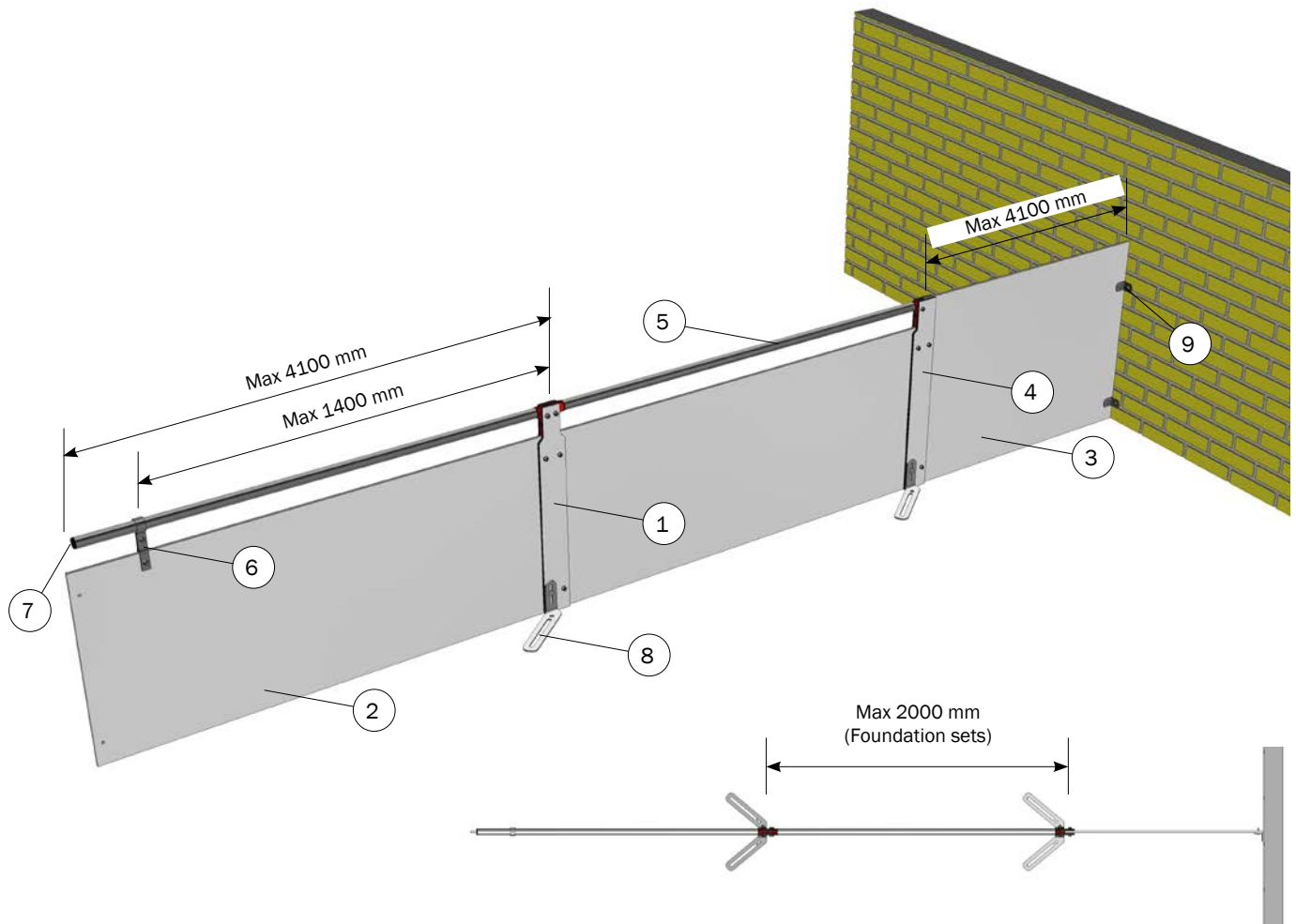

BILL OF MATERIALS

	Item no.	Description	Pcs.
		<i>FIBER_750_13</i>	
1	4300438	POST KIT H75 FOR 1 BAR/PLATE	1
2	4560647	SIDE H64,2 PLATE MAX. LENGTH 4100 MM	2
3	4360475	SIDE H75 PLATE	1
4	4300440	POST KIT H75 COMBI PLATE/BAR	1
5	4310410	1 BAR 1' GALVANIZED, PRICE PER METER	1
6	4300481	1 PCS STIFFENING BRACKET SET FOR 1 BAR ON PLATE	1
7	9960006	ROUND CAP BLACK (1' PIPE)	1
8	4500655	LOOSE FOUNDATION SET, LEFT AND RIGHT, FOR BOARD PROFILE	2
9	4500661	MOUNTING KIT FOR PARTITION AGAINST WALL	1

Fiber_750_14

NOTE:

- Plate length: max 4100 mm
(The plate length should be near 4100 mm to avoid waste)
- Distance between foundation sets: max 2000 mm
(If the distance exceeds 2000 mm, a support foundation is mounted)
- Bar length: max 6000 mm
(Stiffening bracket per max 1400 mm)
- Grille against feeder: see Table 1 below

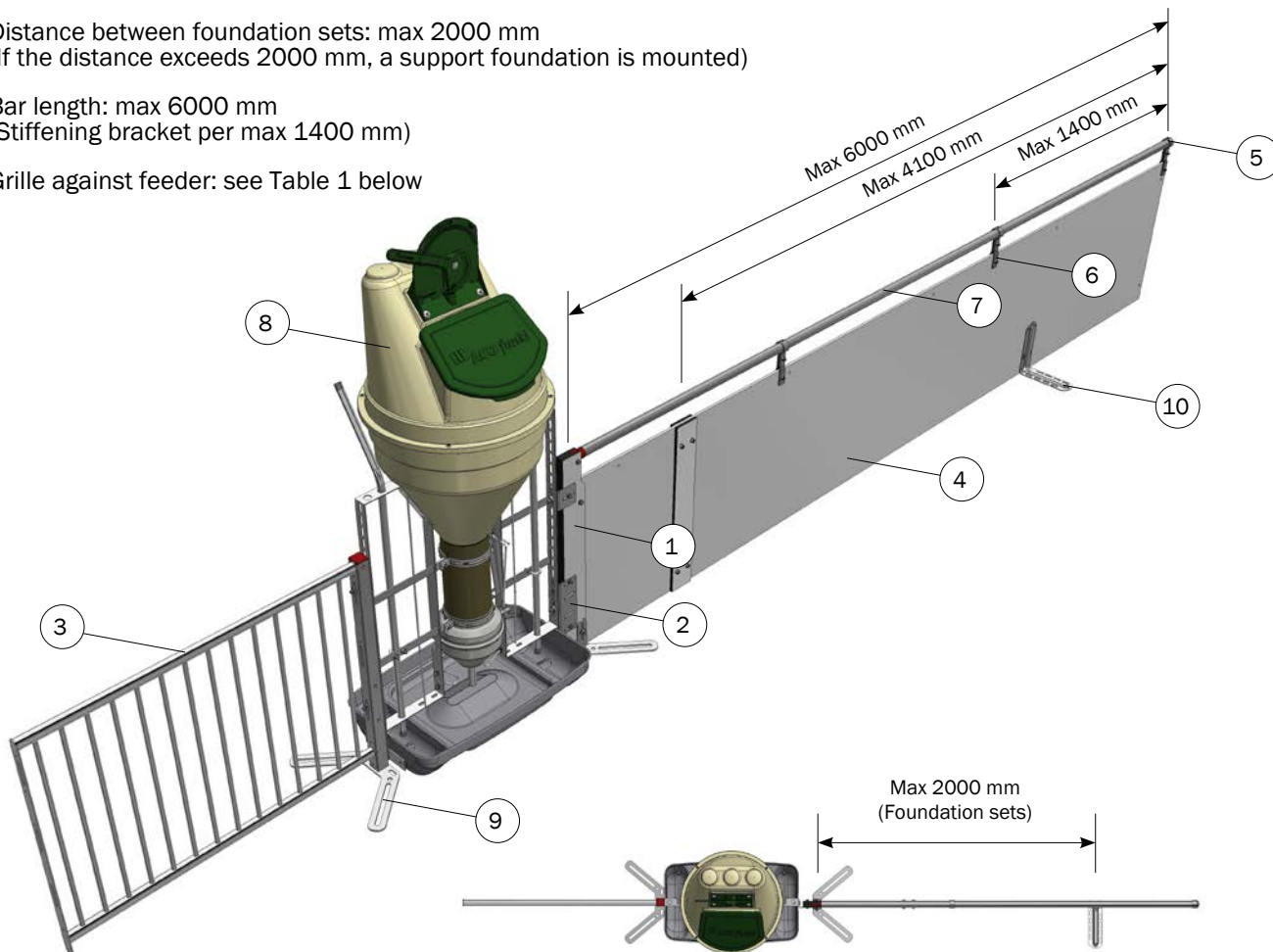

TABLE 1 - GRILLE AGAINST FEEDER

Height, mm	L = 1040 mm	L = 1260 mm	L = 1540 mm
995	4200104	4200126	4200154
870	4400104	4400126	4400154
745	3200104	3200126	3200154

BILL OF MATERIALS

	Item no.	Description	Pcs.
		<i>FIBER_750_14</i>	
1	4300445	POST PLATE H75 1 BAR/PLATE FOR FEEDER	1
2	38524	MOUNTING KIT FOR U-POST AGAINST FEEDERS	1
3	3200104	GRILLE FOR CLEAN-O-FLEX 750/1040 WITH POST	1
4	4510648	SIDE H64,2 PLATE LENGTH 4100-6000 MM	1
5	9960006	ROUND CAP BLACK (1' PIPE)	1
6	4300483	3 PCS STIFFENING BRACKET SET FOR 1 BAR ON PLATE	1
7	4310410	1 BAR 1' GALVANIZED, PRICE PER METER	1
8	560710M	FUNKIMAT WEANER WITH STAINLESS STEEL TROUGH (FLAT-FLAT)	1
9	4500655	LOOSE FOUNDATION SET, LEFT AND RIGHT, FOR BOARD PROFILE	2
10	4901802	ROUND CAP BLACK (1' PIPE)	1

Fiber_750_15

NOTE:

- Plate length: max 4100 mm
(The plate length should be near 4100 mm to avoid waste)
- Distance between foundation sets: max 2000 mm
(If the distance exceeds 2000 mm, a support foundation is mounted)
- Bar length: max 6000 mm
(Stiffening bracket per max 1400 mm)
- Grille against feeder: see Table 1 below

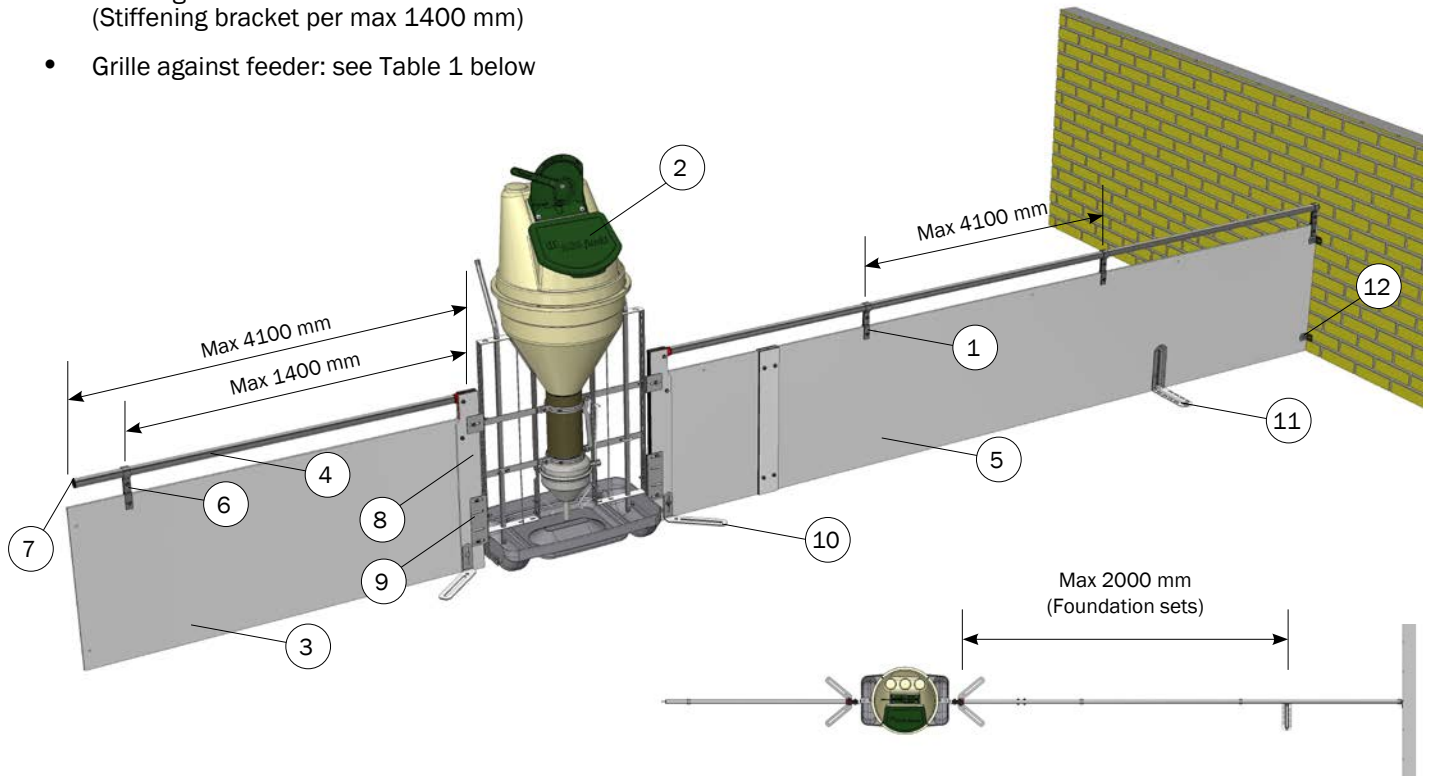

TABLE 1 - GRILLE AGAINST FEEDER

Height, mm	L = 1040 mm	L = 1260 mm	L = 1540 mm
995	4200104	4200126	4200154
870	4400104	4400126	4400154
745	3200104	3200126	3200154

BILL OF MATERIALS

	Item no.	Description	Pcs.
		<i>FIBER_750_15</i>	
1	4300483	3 PCS STIFFENING BRACKET SET FOR 1 BAR ON PLATE	2
2	560710M	FUNKIMAT WEANER WITH STAINLESS STEEL TROUGH (FLAT-FLAT)	2
3	4560647	SIDE H64,2 PLATE MAX. LENGTH 4100 MM	1
4	4310410	1 BAR 1' GALVANIZED, PRICE PER METER	1
5	4510648	SIDE H64,2 PLATE LENGTH 4100-6000 MM	2
6	4300481	1 PCS STIFFENING BRACKET SET FOR 1 BAR ON PLATE	1
7	9960006	ROUND CAP BLACK (1' PIPE)	2
8	4300445	POST PLATE H75 1 BAR/PLATE FOR FEEDER	2
9	38524	MOUNTING KIT FOR U-POST AGAINST FEEDERS	2
10	4500655	LOOSE FOUNDATION SET, LEFT AND RIGHT, FOR BOARD PROFILE	2
11	4901802	SUPPORT FOUNDATION FOR SLATS, FIBER	1
12	4500661	MOUNTING KIT FOR PARTITION AGAINST WALL	1

Fiber_750_16

NOTE:

- Plate length: max 4100 mm
(The plate length should be near 4100 mm to avoid waste)
- Bar length: max 6000 mm
(Stiffening bracket per max 1400 mm)
- Distance between foundation sets: max 2000 mm
(If the distance exceeds 2000 mm, a support foundation is mounted)
- Grille against plate: see Table 2 below

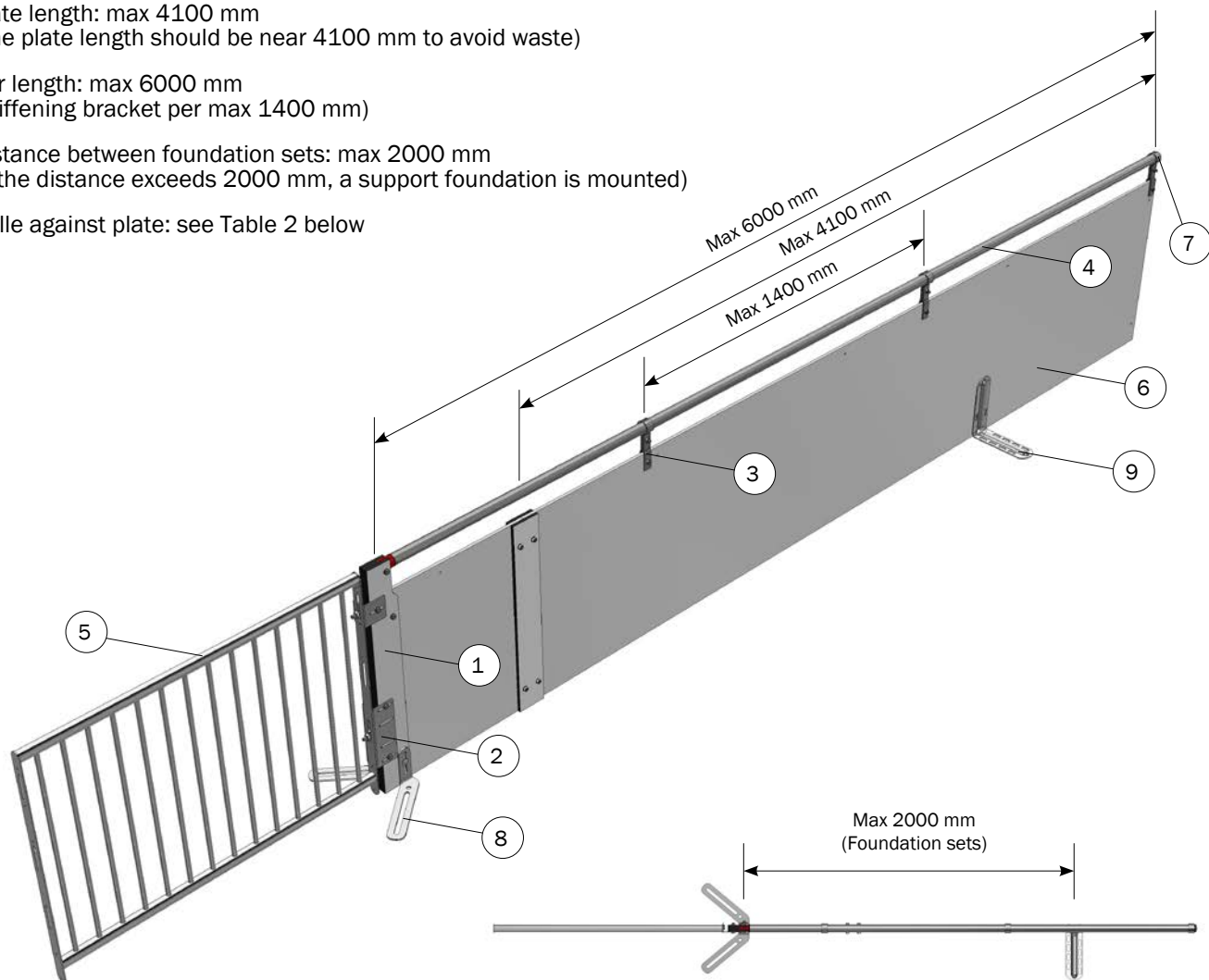

TABLE 2 - GRILLE AGAINST PLATE

Height, mm	L = 1040 mm	L = 1260 mm	L = 1540 mm
995	4150873	4150874	4150875
870	4450873	4450874	4450875
745	3150873	3150874	3150875

BILL OF MATERIALS

	Item no.	Description	Pcs.
		<i>FIBER_750_16</i>	
1	4300445	POST PLATE H75 1 BAR/PLATE FOR FEEDER	1
2	38524	MOUNTING KIT FOR U-POST AGAINST FEEDERS	1
3	4300483	3 PCS STIFFENING BRACKET SET FOR 1 BAR ON PLATE	1
4	4410410	2 BARS 1' GALVANIZED, PRICE PER METER	1
5	3150873	STAINLESS STEEL CONTACT GRILLE H:750 L:1000	1
6	4510648	SIDE H64,2 PLATE LENGTH 4100-6000 MM	1
7	9960006	ROUND CAP BLACK (1' PIPE)	1
8	4500655	LOOSE FOUNDATION SET, LEFT AND RIGHT, FOR BOARD PROFILE	1
9	4901802	SUPPORT FOUNDATION FOR SLATS, FIBER	1

Fiber_750_17

NOTE:

- Plate length: max 4100 mm
(The plate length should be near 4100 mm to avoid waste)
- Bar length: max 6000 mm
(Stiffening bracket per max 1400 mm)
- Distance between foundation sets: max 2000 mm
(If the distance exceeds 2000 mm, a support foundation is mounted)

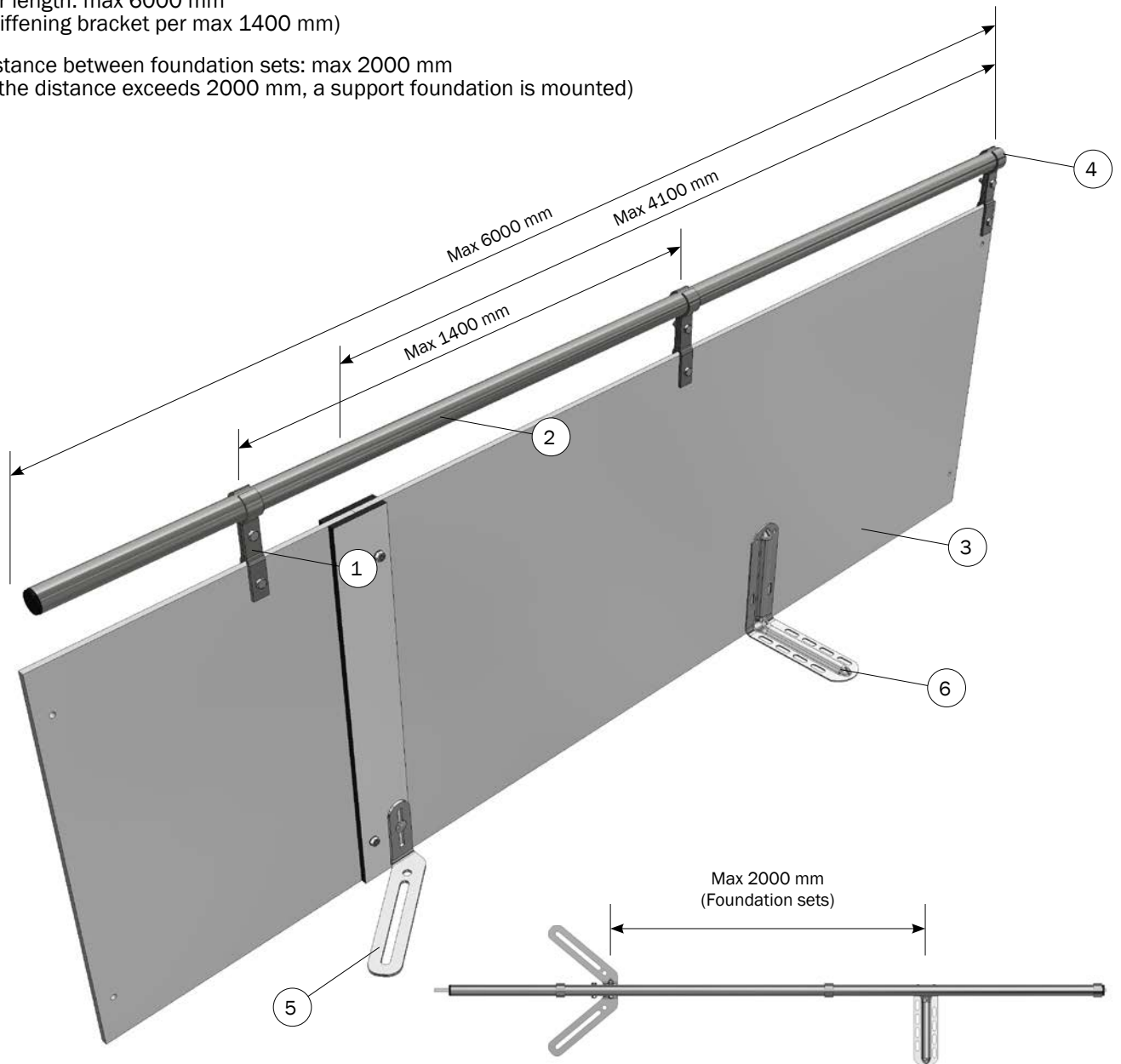

BILL OF MATERIALS

	Item no.	Description	Pcs.
		<i>FIBER_750_17</i>	
1	4300483	3 PCS STIFFENING BRACKET SET FOR 1 BAR ON PLATE	1
2	4310410	1 BAR 1' GALVANIZED, PRICE PER METER	1
3	4510648	SIDE H64,2 PLATE LENGTH 4100-6000 MM	1
4	9960006	ROUND CAP BLACK (1' PIPE)	2
5	4500655	LOOSE FOUNDATION SET, LEFT AND RIGHT, FOR BOARD PROFILE	1
6	4901802	SUPPORT FOUNDATION FOR SLATS, FIBER	1

Fiber_750_18

NOTE:

- Plate length: max 4100 mm
(The plate length should be near 4100 mm to avoid waste)
- Bar length: max 6000 mm
(Stiffening bracket per max 1400 mm)
- Distance between foundation sets: max 2000 mm
(If the distance exceeds 2000 mm, a support foundation is mounted)

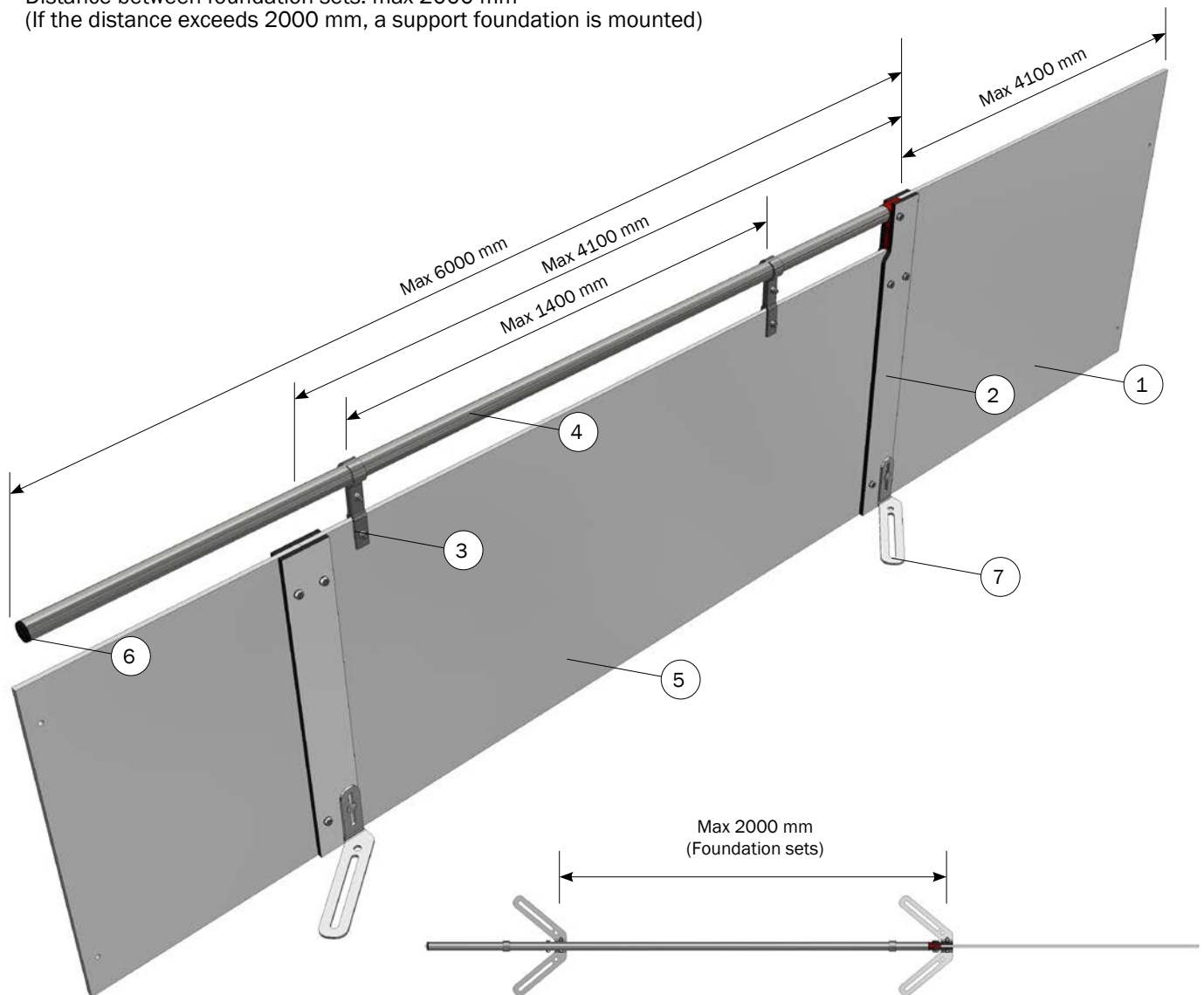

BILL OF MATERIALS			
	Item no.	Description	Pcs.
		<i>FIBER_750_18</i>	
1	4360475	SIDE H75 PLATE	1
2	4300440	POST KIT H75 COMBI PLATE/BAR	1
3	4300482	2 PCS STIFFENING BRACKET SET FOR 1 BAR ON PLATE	1
4	4310410	1 BAR 1' GALVANIZED, PRICE PER METER	1
5	4510648	SIDE H64,2 PLATE LENGTH 4100-6000 MM	1
6	9960006	ROUND CAP BLACK (1' PIPE)	1
7	4500655	LOOSE FOUNDATION SET, LEFT AND RIGHT, FOR BOARD PROFILE	2

Fiber_750_19

NOTE:

- Plate length: max 4100 mm
(The plate length should be near 4100 mm to avoid waste)
- Distance between foundation sets: max 2000 mm
(If the distance exceeds 2000 mm, a support foundation is mounted)
- Bar length: max 6000 mm
(Stiffening bracket per max 1400 mm)
- Grille against feeder: see Table 1 below

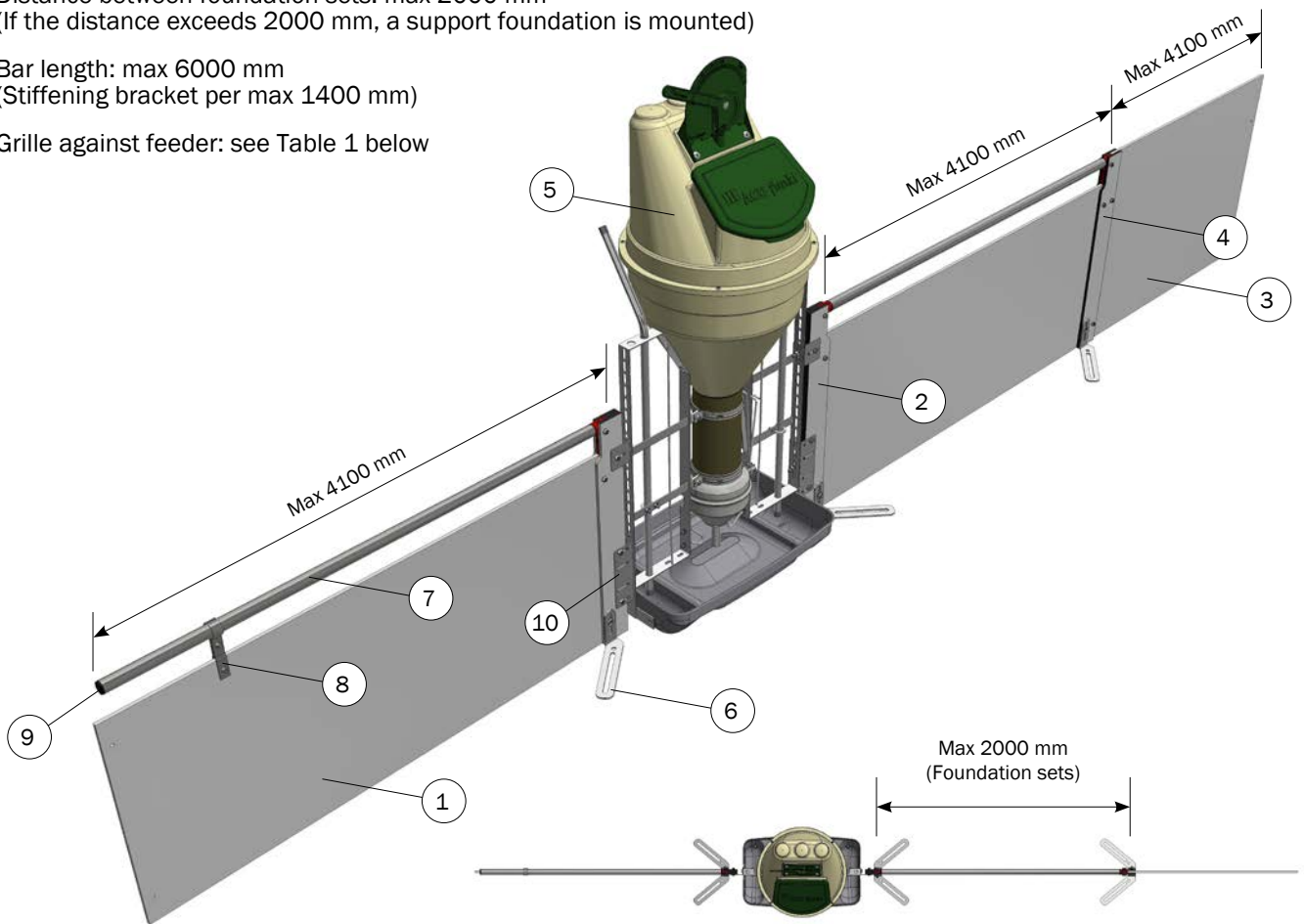

TABLE 1 - GRILLE AGAINST FEEDER

Height, mm	L = 1040 mm	L = 1260 mm	L = 1540 mm
995	4200104	4200126	4200154
870	4400104	4400126	4400154
745	3200104	3200126	3200154

BILL OF MATERIALS

	Item no.	Description	Pcs.
		<i>FIBER_750_19</i>	
1	4560647	SIDE H64,2 PLATE MAX. LENGTH 4100 MM	2
2	4300445	POST PLATE H75 1 BAR/PLATE FOR FEEDER	2
3	4360475	SIDE H75 PLATE	1
4	4300440	POST KIT H75 COMBI PLATE/BAR	1
5	560710M	FUNKIMAT WEANER WITH STAINLESS STEEL TROUGH (FLAT-FLAT)	2
6	4500655	LOOSE FOUNDATION SET, LEFT AND RIGHT, FOR BOARD PROFILE	1
7	4310410	1 BAR 1' GALVANIZED, PRICE PER METER	3
8	4300481	1 PCS STIFFENING BRACKET SET FOR 1 BAR ON PLATE	2
9	9960006	ROUND CAP BLACK (1' PIPE)	1
10	38524	MOUNTING KIT FOR U-POST AGAINST FEEDERS	1

Fiber_750_20

NOTE:

- Plate length: max 4100 mm
(The plate length should be near 4100 mm to avoid waste)
- Distance between foundation sets: max 2000 mm
(If the distance exceeds 2000 mm, a support foundation is mounted)
- Bar length: max 6000 mm
(Stiffening bracket per max 1400 mm)
- Front part length: max 4100 mm
(Front part hinge side: 300 mm (fixed))
- Gate length: 1200 / 1300 / 600 - 1300 mm
- Front part receiver side > 400 mm, 4310404
Front part receiver side < 400 mm, 4310407

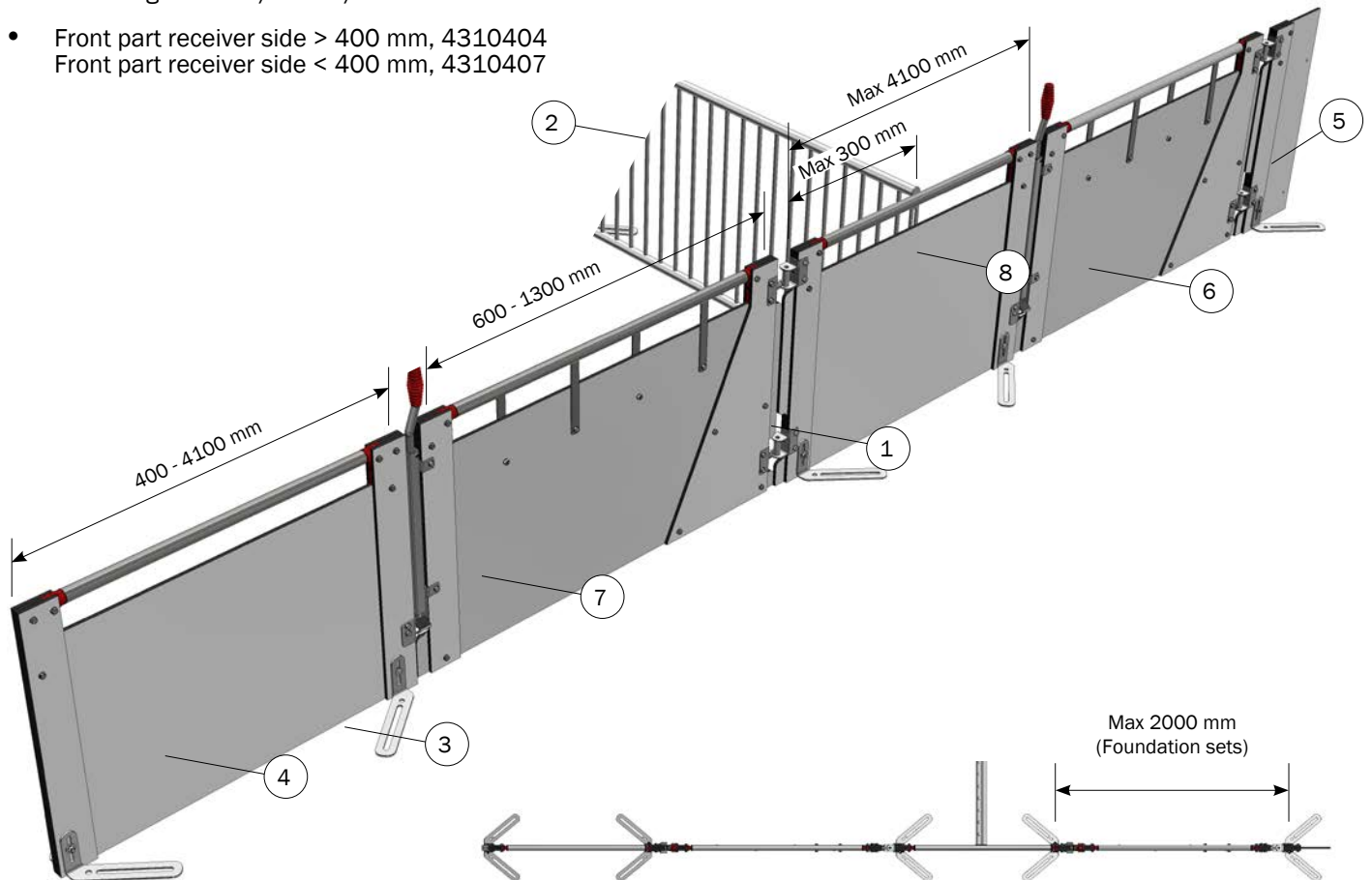

BILL OF MATERIALS			
	Item no.	Description	Pcs.
		<i>FIBER_750_20</i>	
1	4310401	FRONT PART H75 PLATE/1 BAR HINGE/RECEIVER	1
2	3200154	GRILLE FOR CLEAN-O-FLEX 750/1540 WITH POST	1
3	4500655	LOOSE FOUNDATION SET, LEFT AND RIGHT, FOR BOARD PROFILE	6
4	4310404	FRONT PART H75 PLATE/1 BAR WALL/RECEIVER	1
5	4310406	FRONT PART H75 PLATE AGAINST WALL/HINGE 300 MM	1
6	4310420	GATE H75 PLATE/1 BAR 120 CM WITH PIN LOCK	1
7	4310435	GATE H75 PLATE/1 BAR 60-130 CM WITH PIN LOCK	1
8	4500452	MONTAGE SÆT TIL GITTER/ FRONTSTYKKE	1

Fiber_750_21

NOTE:

- Plate length: max 4100 mm
(The plate length should be near 4100 mm to avoid waste)
- Distance between foundation sets: max 2000 mm
(If the distance exceeds 2000 mm, a support foundation is mounted)
- Bar length: max 6000 mm
(Stiffening bracket per max 1400 mm)
- Front part length: max 4100 mm
(Front part hinge side: 300 mm (fixed))
- Gate length: 1200 / 1300 / 600 - 1300 mm
- Front part receiver side > 400 mm, 4610404
Front part receiver side < 400 mm, 4610407

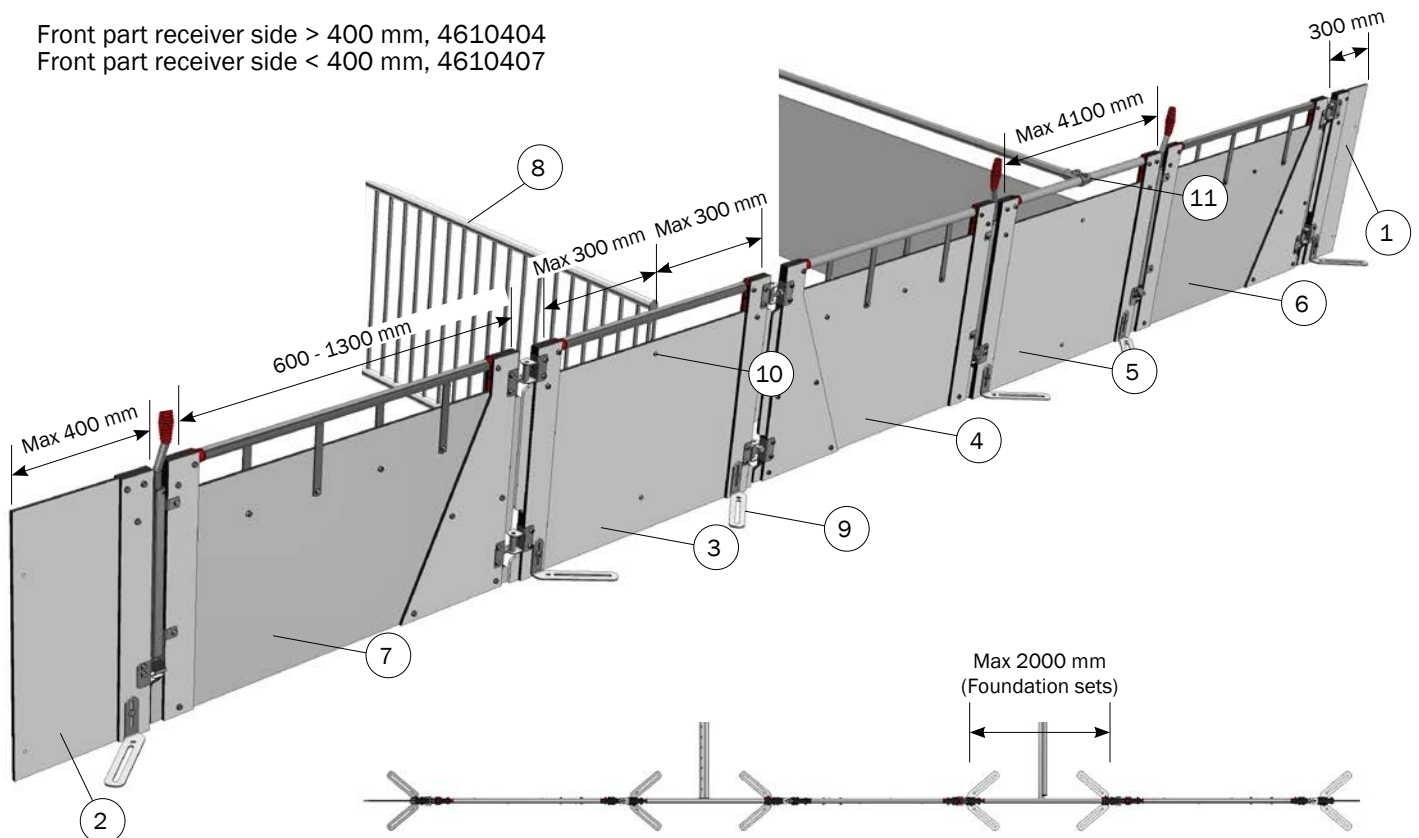

BILL OF MATERIALS

	Item no.	Description	Pcs.
		<i>FIBER_750_20</i>	
1	4310406	FRONT PART H75 PLATE AGAINST WALL/HINGE 300 MM	1
2	4310407	FRONT PART H75 PLATE AGAINST WALL/RECEIVER MAX. 400 MM	1
3	4310402	FRONT PART H75 PLATE/1 BAR HINGE/HINGE	1
4	4310420	GATE H75 PLATE/1 BAR 120 CM WITH PIN LOCK	1
5	4310403	FRONT PART H75 PLATE/1 BAR RECEIVER/RECEIVER	1
6	4310430	GATE H75 PLATE/1 BAR 120 CM WITH PIN LOCK	1
7	4310435	GATE H75 PLATE/1 BAR 60-130 CM WITH PIN LOCK	1
8	3200154	GRILLE FOR CLEAN-O-FLEX 750/1540 WITH POST	1
9	4500655	LOOSE FOUNDATION SET, LEFT AND RIGHT, FOR BOARD PROFILE	6
10	4500452	MOUNTING KIT FOR GRILLE/FRONT PART	1
11	38551	MOUNTING KIT PLATE/1 BAR WITH UPROFILE AGAINST FRONT PART	1

Fiber_750_22

NOTE:

- Plate length: max 4100 mm
(The plate length should be near 4100 mm to avoid waste)
- Distance between foundation sets: max 2000 mm
(If the distance exceeds 2000 mm, a support foundation is mounted)
- Bar length: max 6000 mm
(Stiffening bracket per max 1400 mm)
- Front part length (full length): max 2000 mm
- Full length gate: 900 - 2500 mm

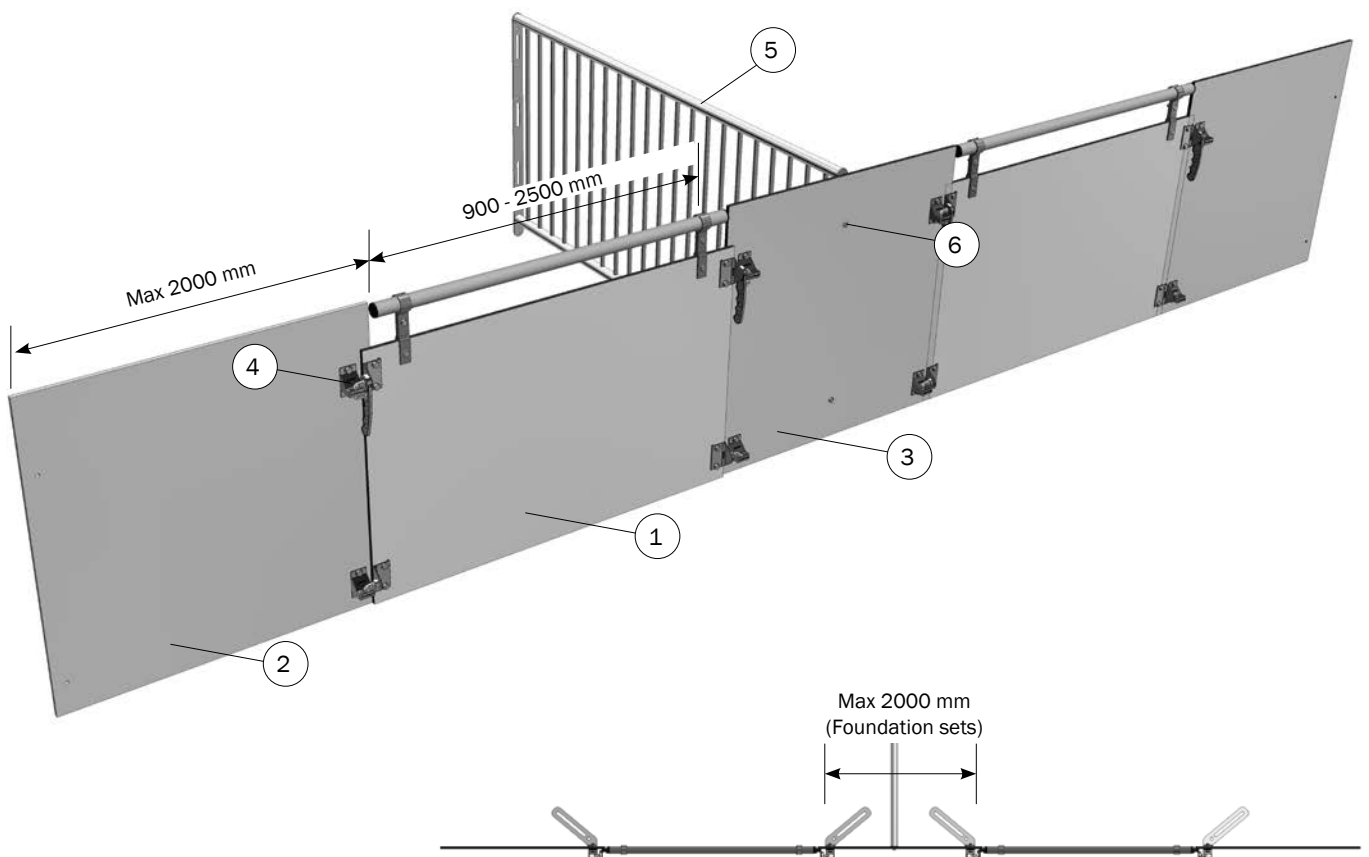

BILL OF MATERIALS

	Item no.	Description	Pcs.
		<i>FIBER_750_22</i>	
1	4310465	GATE FULL PEN H75 PLATE/1 BAR 90-250 CM	2
2	4360471	FRONT PART H75 PLATE GATE FULL PEN FOR 2 HINGES	2
3	4360473	FRONT PART H75 PLATE GATE FULL PEN FOR 4 HINGES	1
4	4500644	MOUNTING KIT FOR FRONT PART FOR GATE FULL PEN, INCL FOUNDATION PLATE	2
5	3200154	GRILLE FOR CLEAN-O-FLEX 750/1540 WITH POST	1
6	4500452	MOUNTING KIT FOR GRILLE/FRONT PART	1

Fiber_750_23

NOTE:

- Plate length: max 4100 mm
(The plate length should be near 4100 mm to avoid waste)
- For full-height plates, use stabilisation posts 38909 or 38917
- Mount stabilisation posts on both sides of all assembly posts
(Do not mount stabilisation posts directly on the plate, unless it is the outermost plate against e.g. a wall)

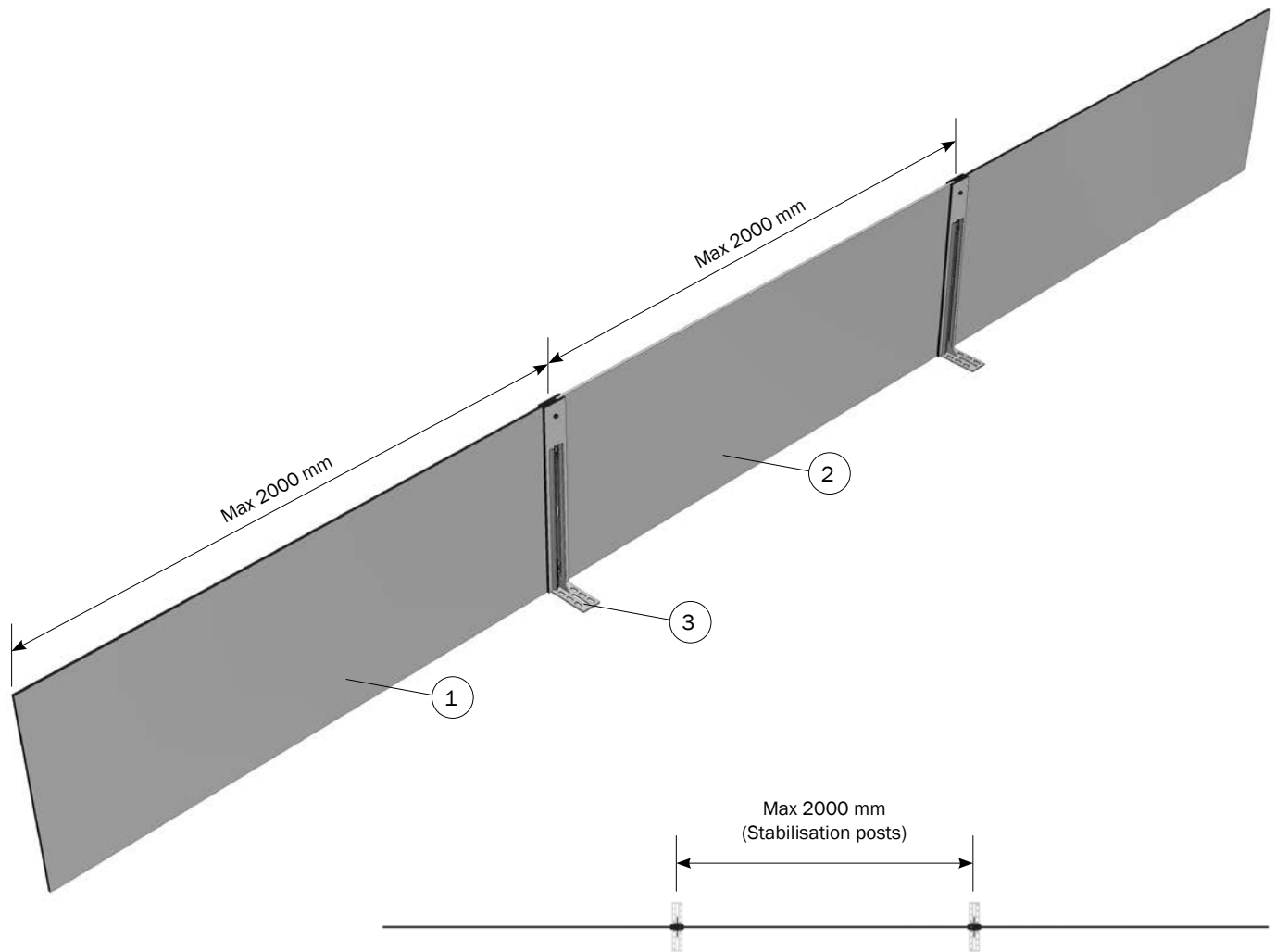

BILL OF MATERIALS

	Item no.	Description	Pcs.
		<i>FIBER_750_23</i>	
1	4360451	WASHING WALL H75 PLATE	3
2	4310448	ASSEMBLER KIT FOR WASHING WALL H75	2
3	38910	STABILISATION POST H58 CM	2