

MOUNTING INSTRUCTION

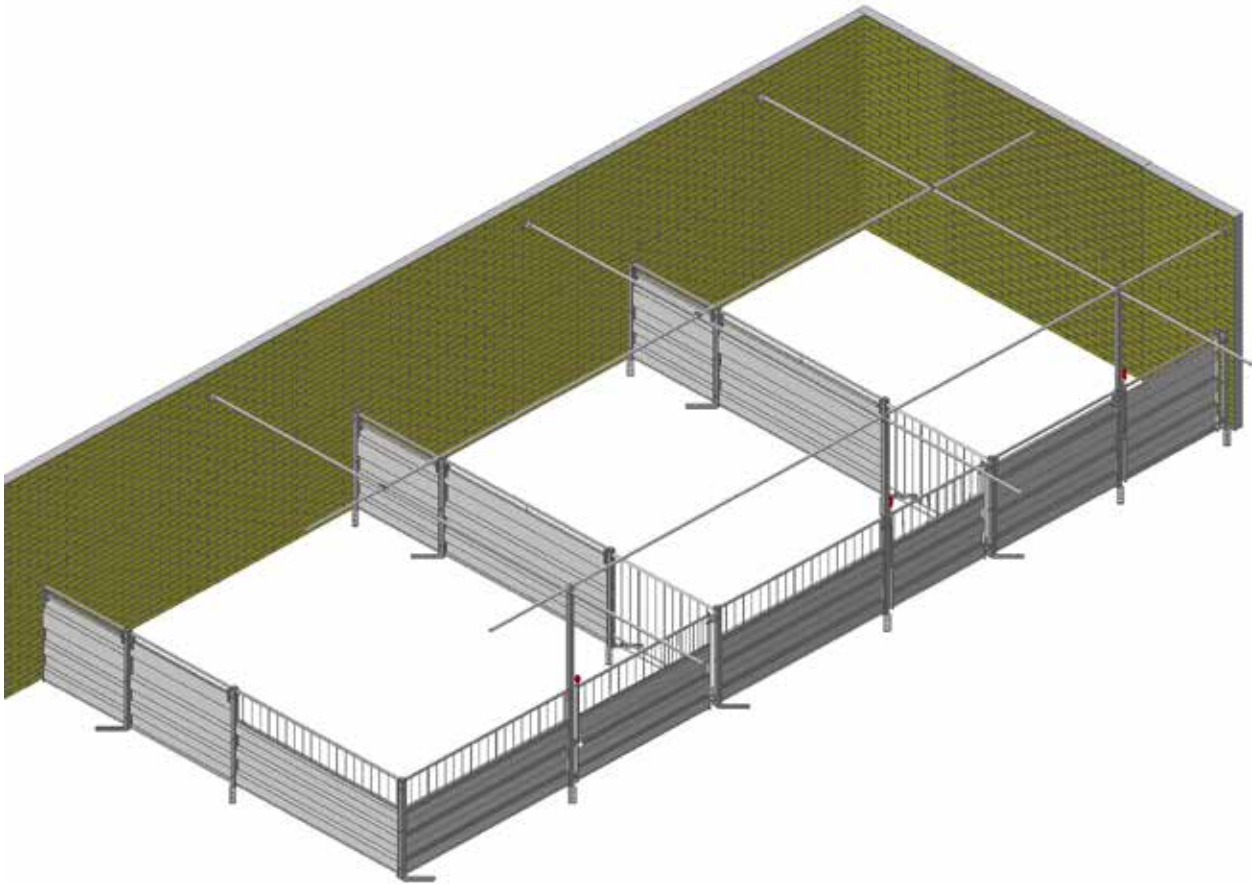

INN-O-FLEX STEEL



ACO FUNKI A/S
Kirkevænget 5
DK-7400 Herning

Tel. +45 9711 9600
Fax +45 9711 9677
www.acofunki.com

DANISH DESIGN | GERMAN QUALITY | GLOBAL EXPERIENCE

PRODUCT AND MOUNTING OVERVIEW FOR INN-O-FLEX STEEL

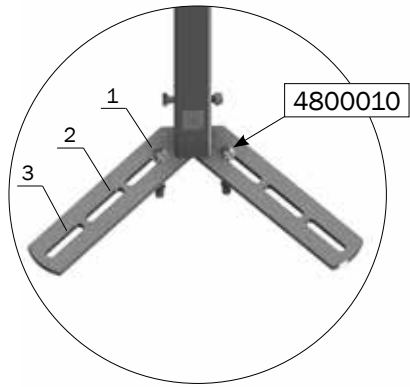

Can use 3 positions to attach post with floor.

The closer the screw is placed to the post, the more stable the post will be.

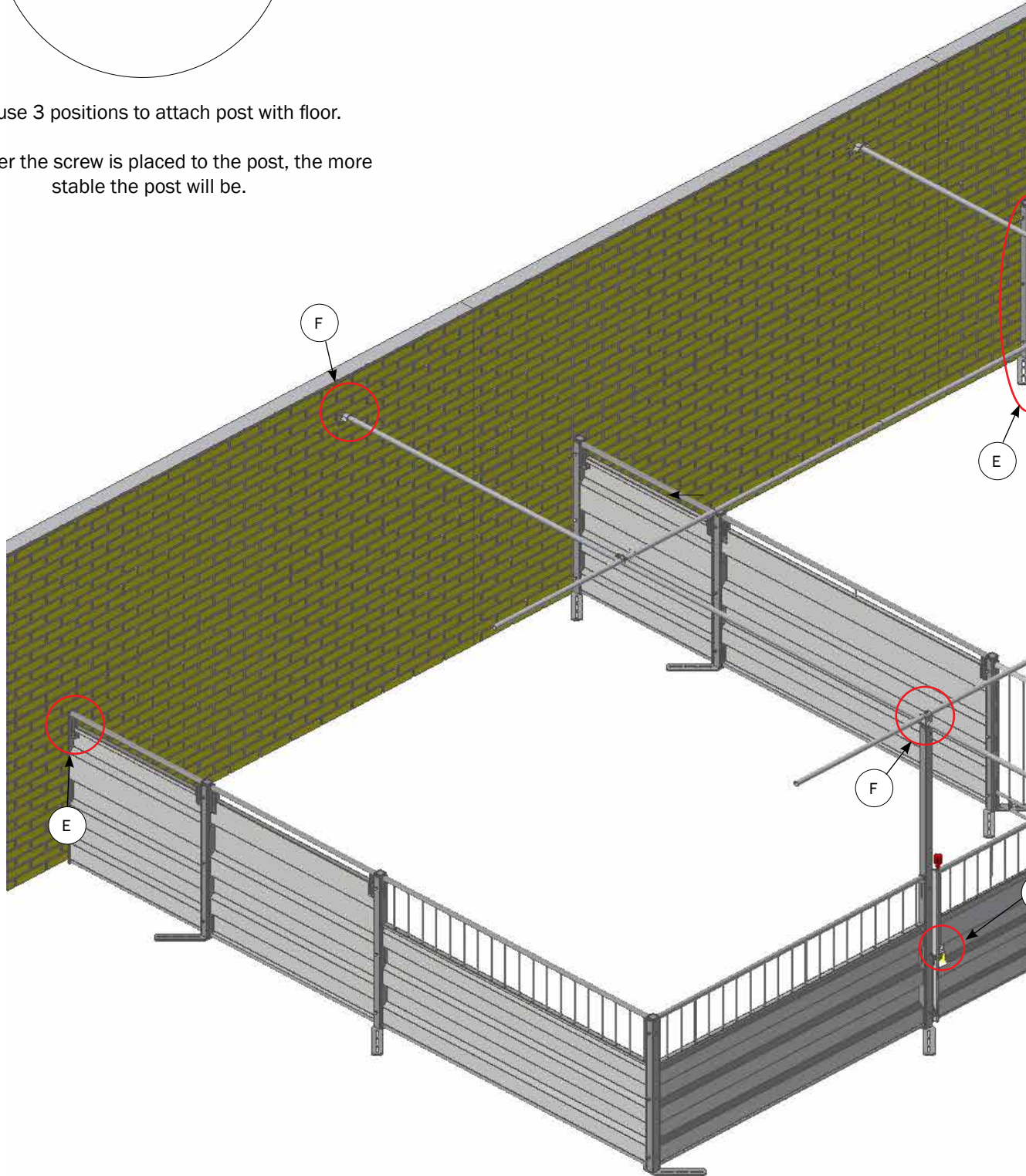

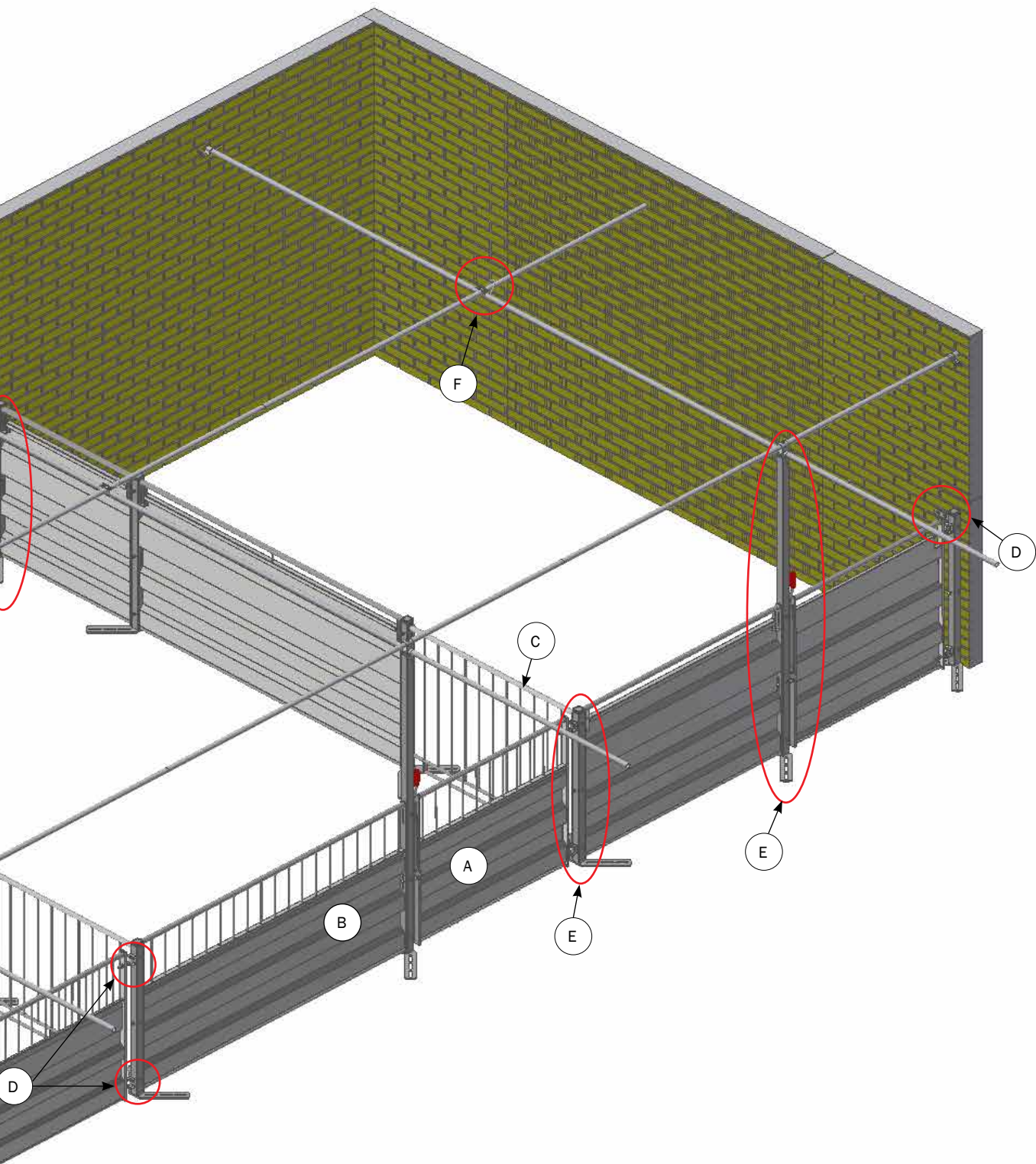

NO.	PAGE	DESCRIPTION
A	4-9	PARTS LIST OF GATE
B	10-13	PARTS LIST OF SIDE
C	14-15	GRILLE OVERVIEW
D	16-20	MOUNTING OF GATE
E	21-22	MOUNTING OG LOW/HIGH POST
F	23-26	MOUNTING OF STABILIZATIONPIPE

GATE FOR INN-O-FLEX H110 GRILLE/STEEL 1600-1790 MM WITH PIN LOCK

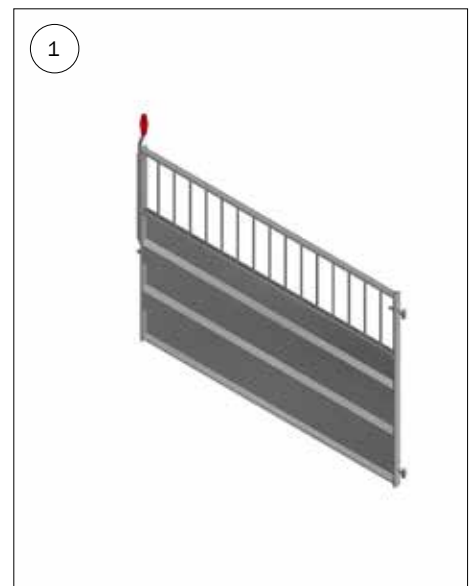
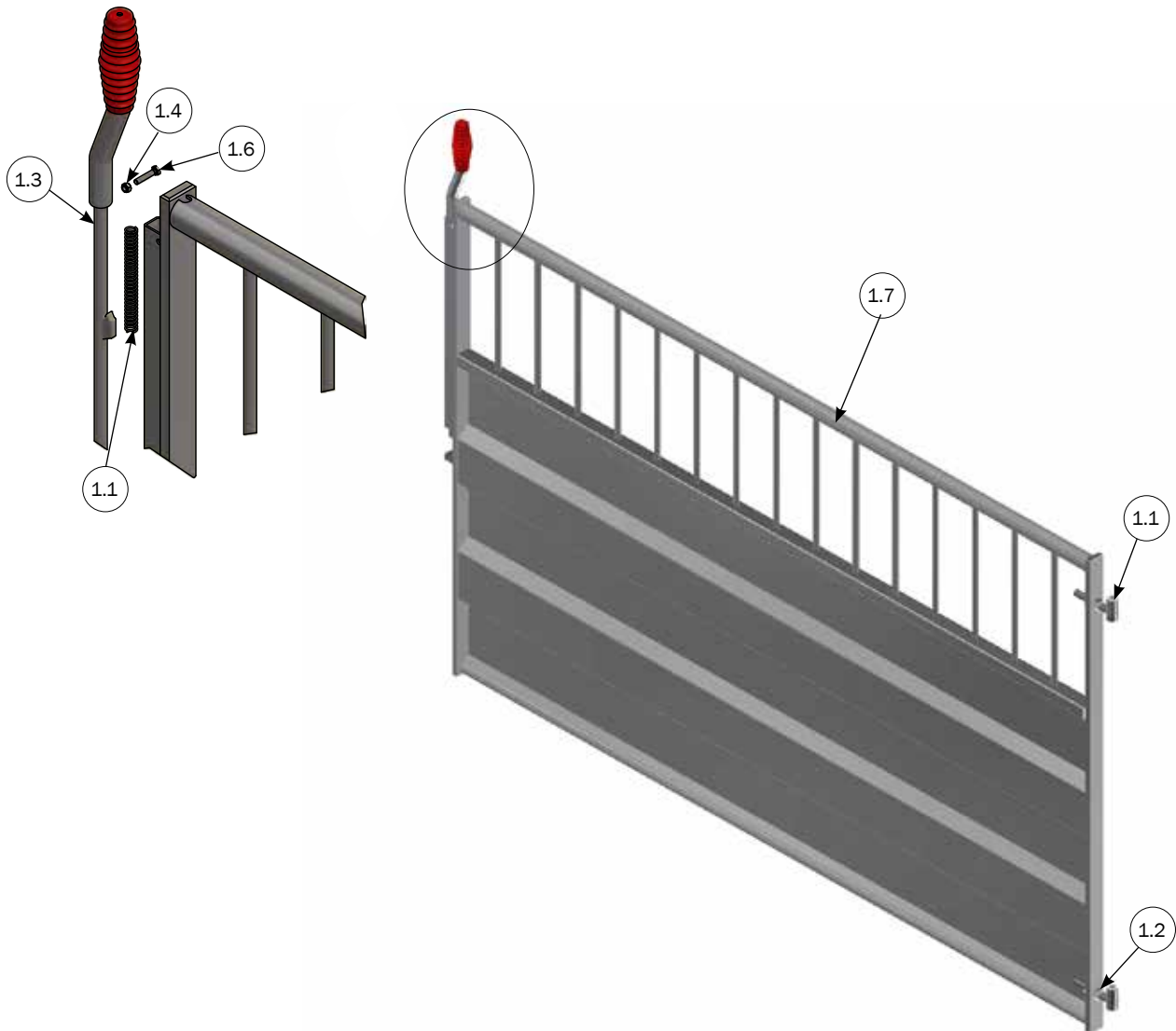

NO.	ITEM NO.	DESCRIPTION
1	4010698	GATE H110 STEEL/GRILLE 1600-1790 MM WITH PIN LOCK, INN-O-FLEX
1.1	4550427	INN-O-FLEX STUD BOLT COMPLET
1.2	68598	NUT M14 SS
1.3	4105183	PIN LOCK FOR GATE INCL. GRIP
1.4	33905000	LOCK NUT M5 A2 DIN 985
1.5	9929004	COMPRESSION SPRING 1,6X12X115 MM
1.6	30305025	SET SCREW M5X25 A2 DIN 933
1.7	4020698	GATE H110 GRILLE/STEEL 1600-1790 MM FOR PIN LOCK

GATE FOR INN-O-FLEX H110 STEEL 1200-1790 MM WITH PIN LOCK

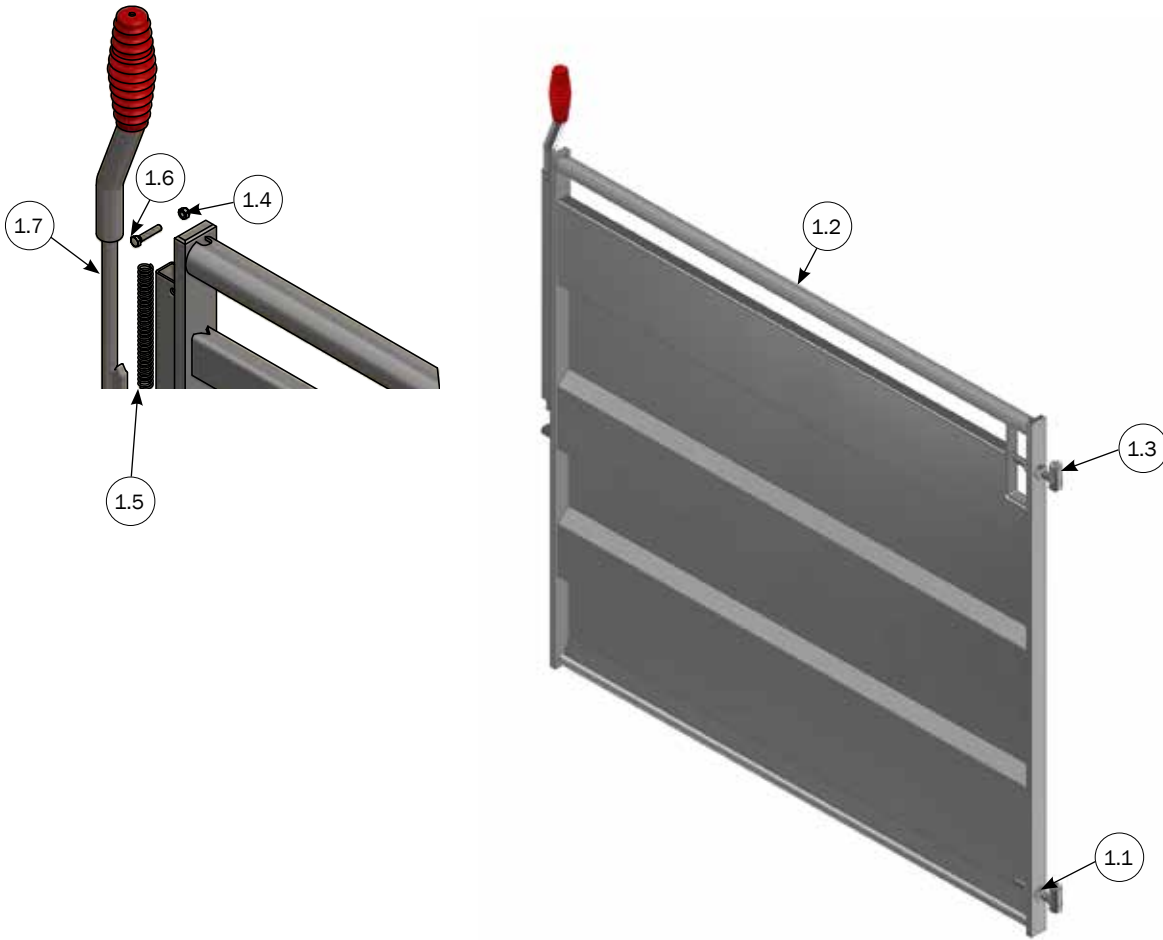

NO.	ITEM NO.	DESCRIPTION
	4010788	GATE H110 STEEL 1600-1790 MM WITH PIN LOCK, INN-O-FLEX
	4010787	GATE H110 STEEL 1400-1590 MM WITH PIN LOCK, INN-O-FLEX
1	4010786	GATE H110 STEEL 1200-1390 MM WITH PIN LOCK, INN-O-FLEX
1.1	68598	NUT M14 SS
1.2	4020696	GATE H110 STEEL 1200-1390 MM FOR PIN LOCK
1.3	4550427	INN-O-FLEX STUD BOLT COMPLET
1.4	33905000	LOCK NUT M5 A2 DIN 985
1.5	9929004	COMPRESSION SPRING 1,6X12X115 MM
1.6	30305025	SET SCREW M5X25 A2 DIN 933
1.7	4105183	PIN LOCK FOR GATE INCL. GRIP



GATE FOR INN-O-FLEX H110 STEEL/GRILLE 1200-1790 MM WITH TWIST

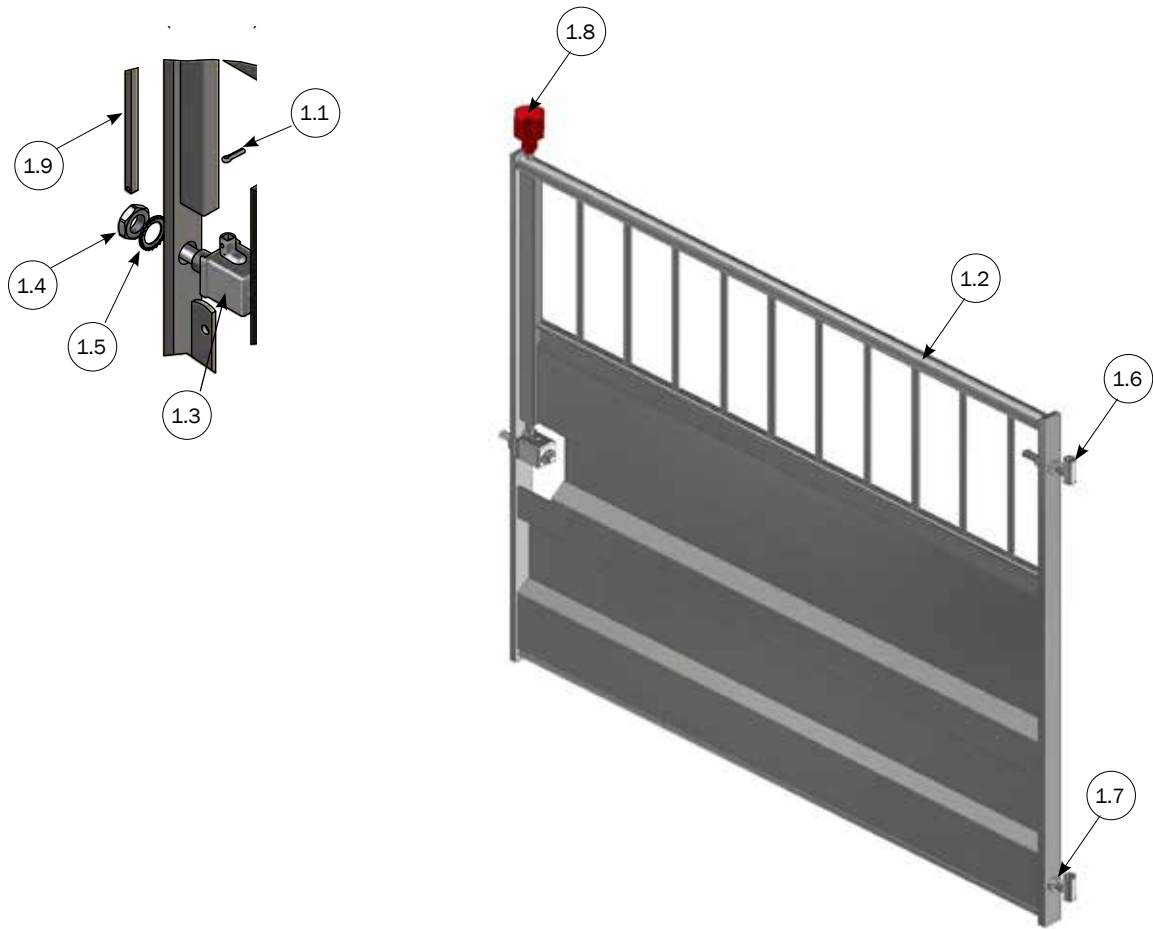

NO.	ITEM NO.	DESCRIPTION
	4010778	GATE H110 STEEL/GRILL 1600-1790 MM WITH TWIST, INN-O-FLEX
	4010777	GATE H110 STEEL/GRILL 1400-1590 MM WITH TWIST, INN-O-FLEX
1	4010776	GATE H110 STEEL/GRILL 1200-1390 MM WITH TWIST, INN-O-FLEX
1.1	68895	4 X 20 RIVET
1.2	4020676	GATE H110 GRILL/STEEL 1200-1390 MM FOR TWIST
1.3	17120	CASE TURN LOCK
1.4	68593	LOCK NUT A2 20 X 1,5
1.5	68763	LOCK WASHER 20 MM DIN6798A
1.6	4550427	INN-O-FLEX STUD BOLT COMPLET
1.7	68598	NUT M14 SS
1.8	30020	KNOB TURN ROD CLEAN-O-FLEX®/INN-O-FLEX
1.9	8050114	TURN ROD 645 MM

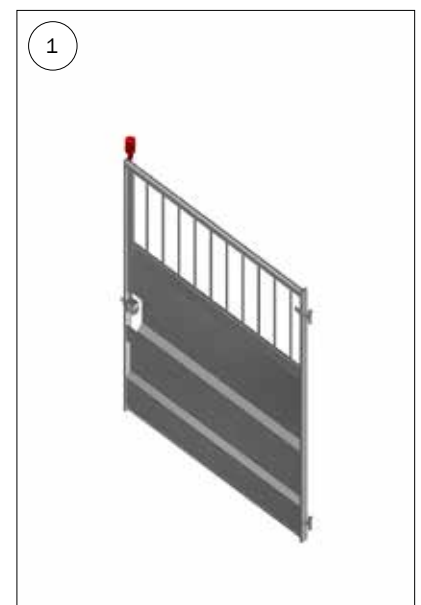

GATE FOR INN-O-FLEX STEEL 1200-1790 MM WITH TWIST

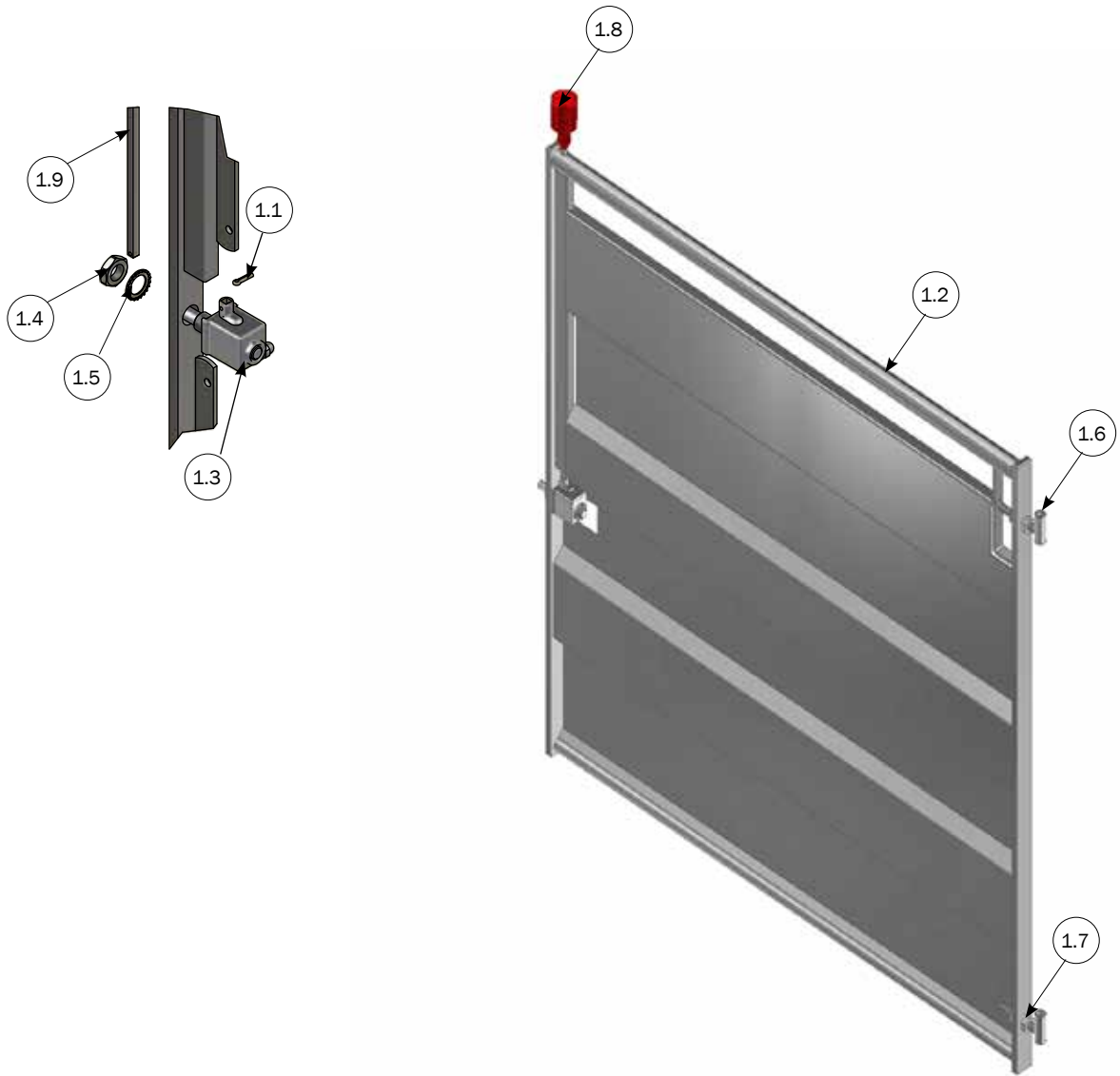

NO.	ITEM NO.	DESCRIPTION
	4010768	GATE H110 PLATE 1600-1790 MM WITH TWIST, INN-O-FLEX
	4010767	GATE H110 PLATE 1400-1590 MM WITH TWIST, INN-O-FLEX
1	4010766	GATE H110 PLATE 1200-1390 MM WITH TWIST, INN-O-FLEX
1.1	68895	4 X 20 RIVET
1.2	4020666	GATE H110 STEEL 1200-1390 MM FOR TWIST
1.3	17120	CASE TURN LOCK
1.4	68593	LOCK NUT A2 20 X 1,5
1.5	68763	LOCK WASHER 20 MM DIN6798A
1.6	4550427	INN-O-FLEX STUD BOLT COMPLET
1.7	68598	NUT M14 SS
1.8	30020	KNOB TURN ROD CLEAN-O-FLEX®/INN-O-FLEX
1.9	8050114	TURN ROD 645 MM



GRILLE GATE FOR INN-O-FLEX 10 MM H110 WITH PIN LOCK

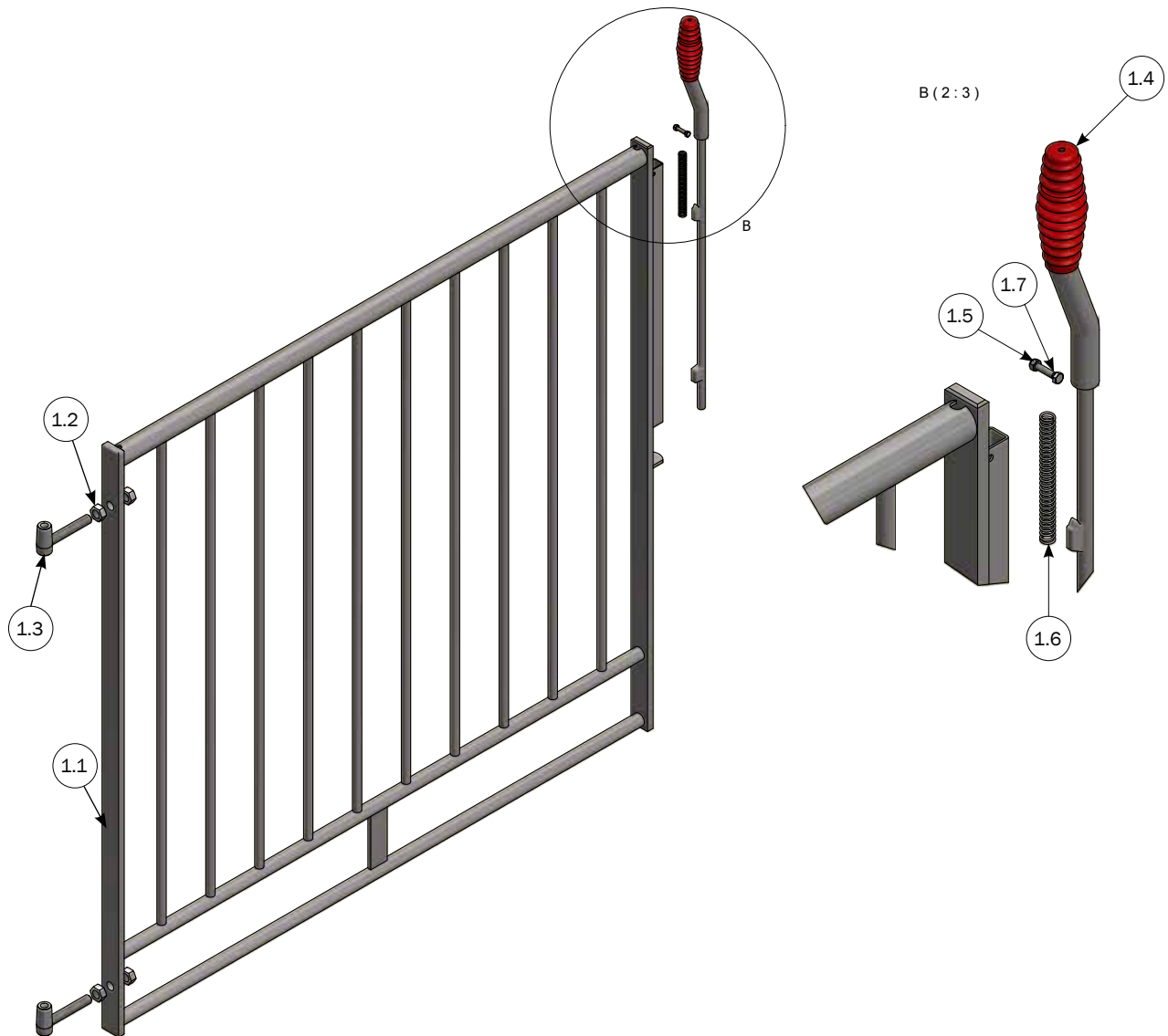

NO.	ITEM NO.	DESCRIPTION
	4010638	GATE H110 GRILLE L1250-1750 MM WITH PIN LOCK, INN-O-FLEX
	4010637	GATE H110 GRILLE L1750 MM WITH PIN LOCK, INN-O-FLEX
	4010636	GATE H110 GRILLE L1450 MM WITH PIN LOCK, INN-O-FLEX
1	4010635	GATE H110 GRILLE L1250 MM WITH PIN LOCK, INN-O-FLEX
1.1	4020635	GRILLE 1250 MM FOR PIN LOCK
1.2	4550427	INN-O-FLEX STUD BOLT COMPLET
1.3	68598	NUT M14 SS
1.4	4105183	PIN LOCK FOR GATE INCL. GRIP
1.5	33905000	LOCK NUT M5 A2 DIN 985
1.6	9929004	COMPRESSION SPRING 1,6X12X115 MM
1.7	30305025	SET SCREW M5X25 A2 DIN 933

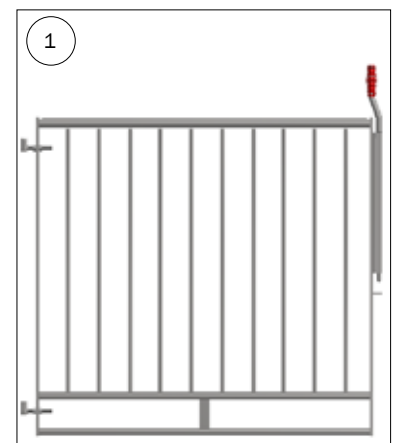

GRILLE GATE FOR INN-O-FLEX 10 MM H110 WITH TWIST

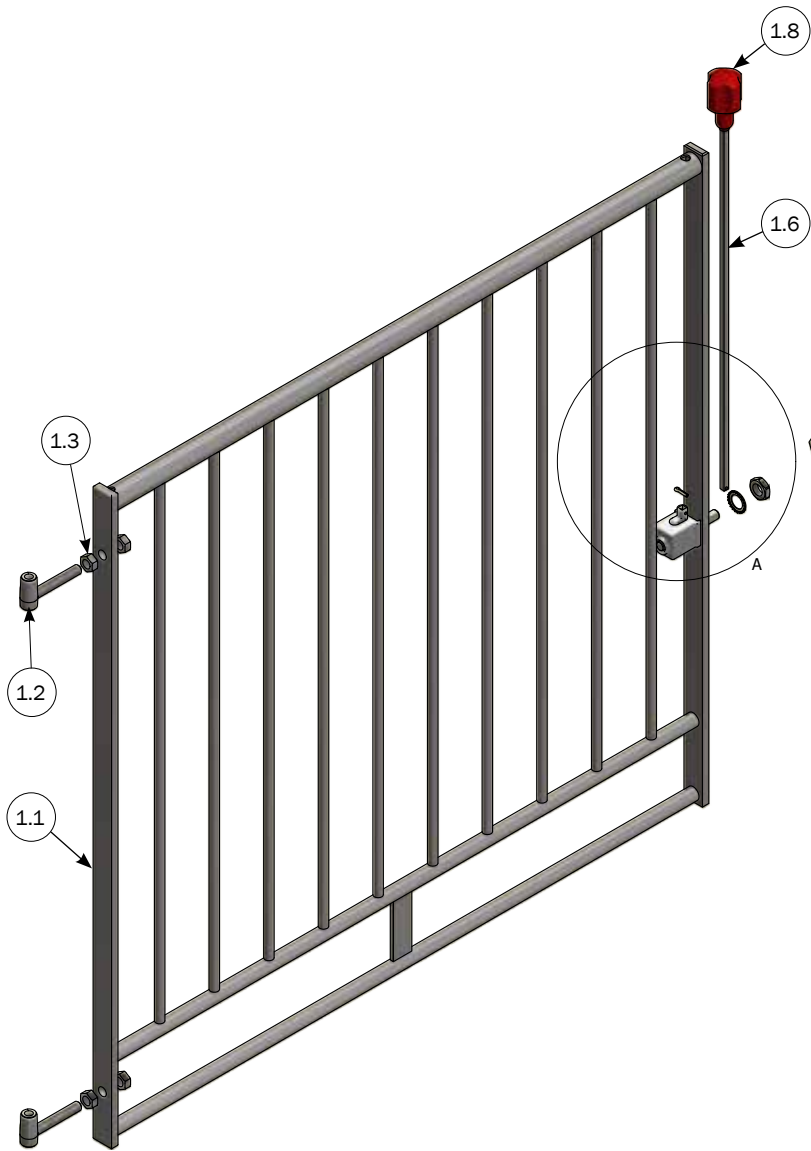

A(2:3)

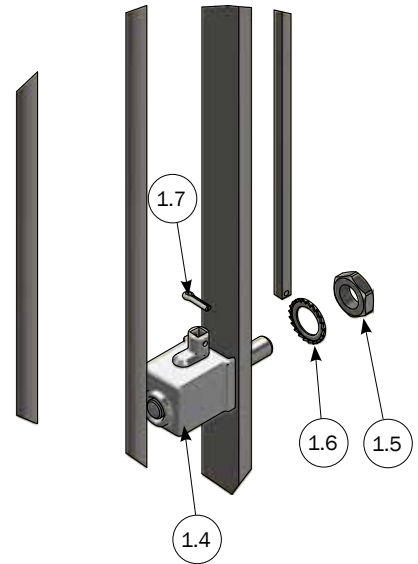

NO.	ITEM NO.	DESCRIPTION
	4010648	GATE H110 GRILLE L1250-1750 MM WITH TWIST, INN-O-FLEX
	4010647	GATE H110 GRILLE L1750 MM WITH TWIST, INN-O-FLEX
	4010646	GATE H110 GRILLE L1450 MM WITH TWIST, INN-O-FLEX
1	4010645	GATE H110 GRILLE L1250 MM WITH TWIST, INN-O-FLEX
1.1	4020645	GRILLE GATE 1250 MM FOR TWIST
1.2	4550427	INN-O-FLEX STUD BOLT COMPLET
1.3	68598	NUT M14 SS
1.4	17120	CASE TURN LOCK
1.5	68593	LOCK NUT A2 20 X 1,5
1.6	68763	LOCK WASHER 20 MM DIN6798A
1.7	68895	4 X 20 RIVET
1.8	30020	KNOB TURN ROD CLEAN-O-FLEX®/INN-O-FLEX
1.9	8050114	TURN ROD 645 MM

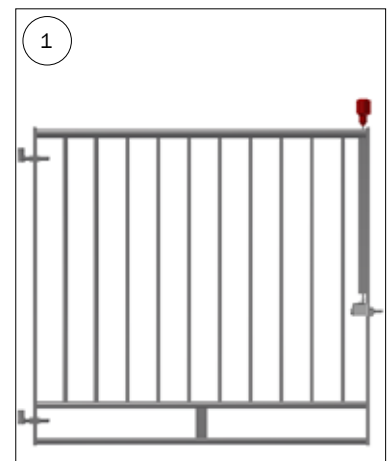

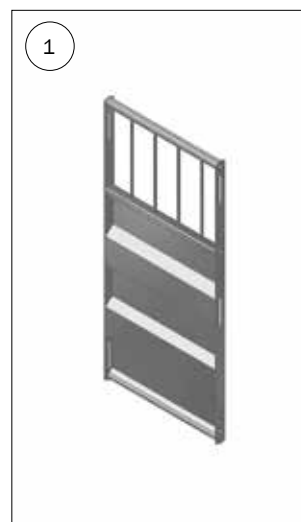

ITEM NO.	DESCRIPTION
4020690	SIDE H110 STEEL/GRILLE 0-500 MM, INN-O-FLEX

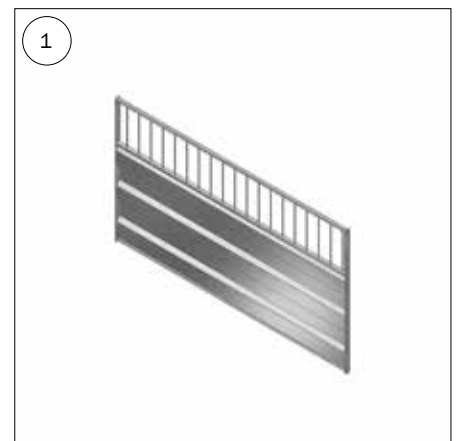
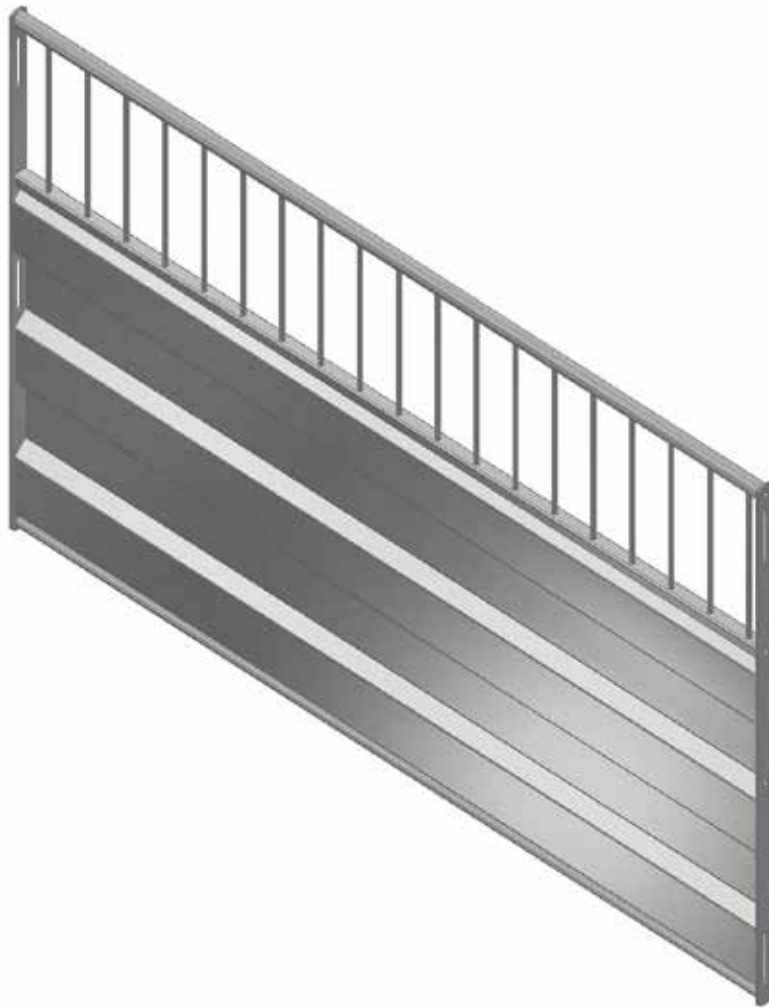

ITEM NO.	DESCRIPTION
4020691	SIDE H110 STEEL/GRILLE 501-1000 MM, INN-O-FLEX
4020692	SIDE H110 STEEL/GRILLE 1001-1500 MM, INN-O-FLEX
4020693	SIDE H110 STEEL/GRILLE 1501-2000 MM, INN-O-FLEX



ITEM NO.	DESCRIPTION
4020780	SIDE H110 STEEL 0-500 MM, INN-O-FLEX

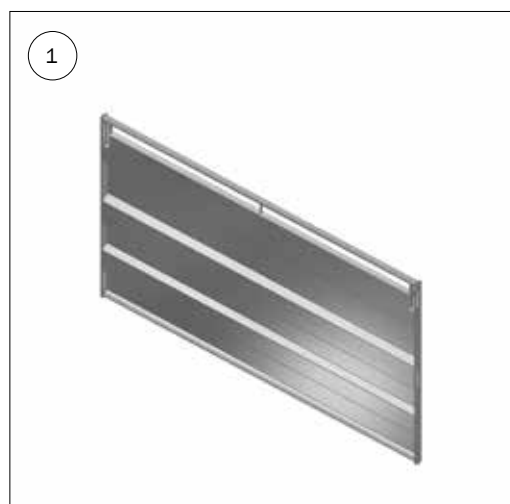

ITEM NO.	DESCRIPTIN
4020781	SIDE H110 STEEL 500-1000 MM, INN-O-FLEX
4020782	SIDE H110 STEEL 1000-1500 MM,INN-O-FLEX
4020783	SIDE H110 STEEL 1500-2000 MM,INN-O-FLEX

GRILLE FOR INN-O-FLEX 40 MM H110 200-2500 MM

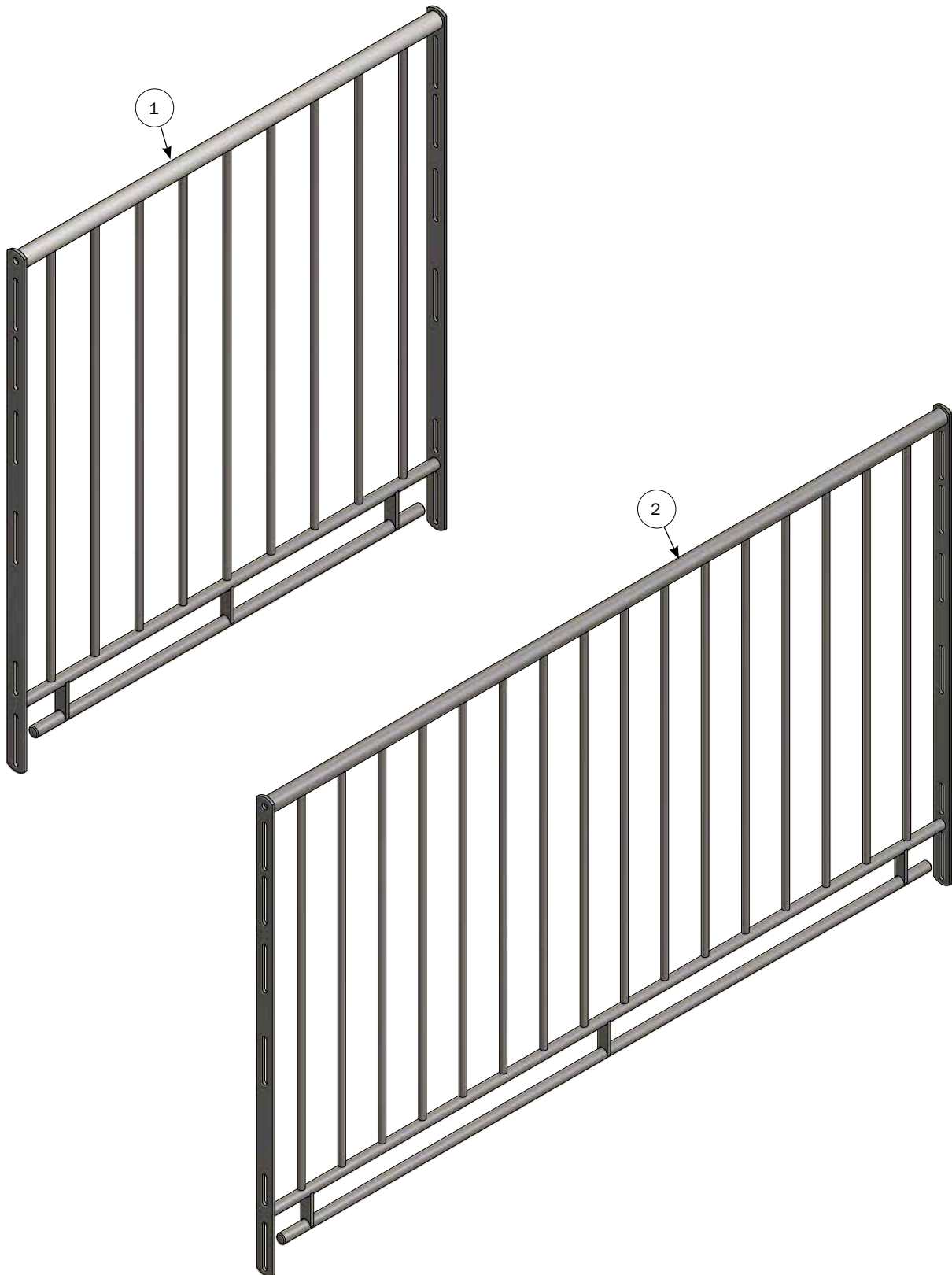

NO.	ITEM NO.	DESCRIPTION
1	4020939	GRILLE H110, L:200-1000 MM
2	4020944	GRILLE H110, L:1750 - 2500 MM

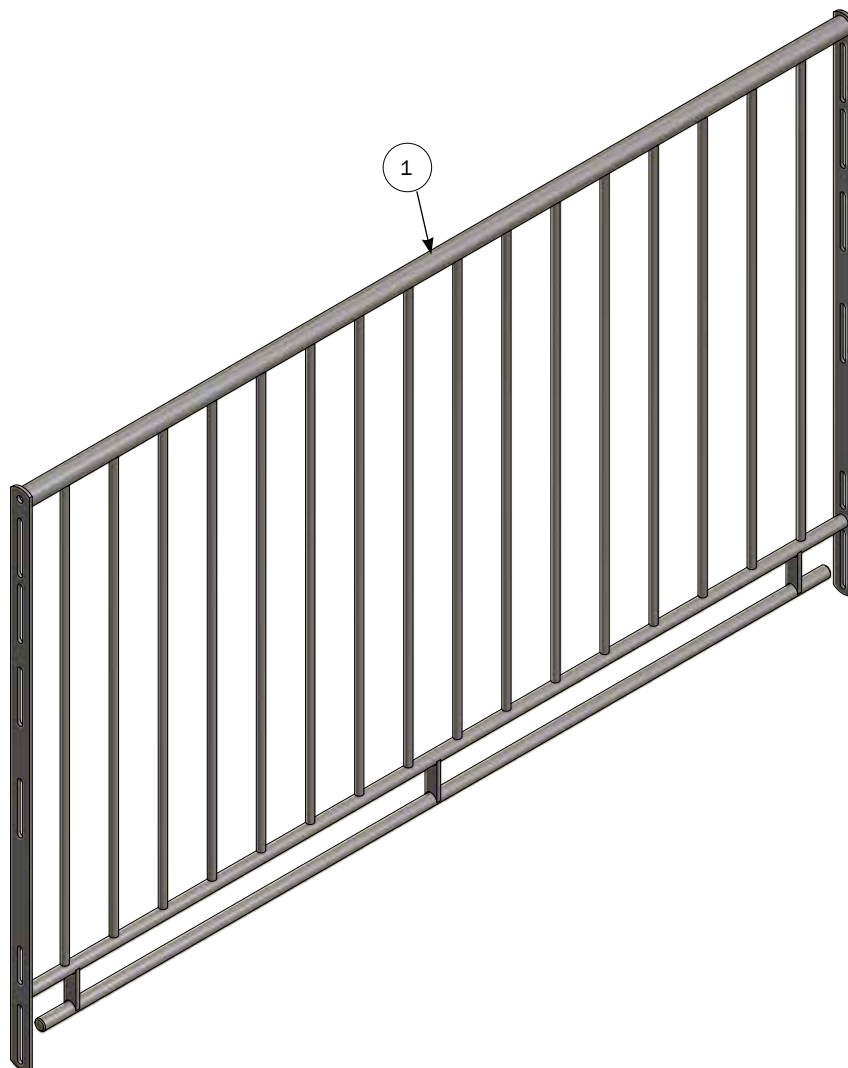

NO.	ITEM NO.	DESCRIPTION
	4020940	GRILLE H110, L:1000 MM
	4020941	GRILLE H110, L:1250 MM
	4020942	GRILLE H110, L:1450 MM
1	4020943	GRILLE H110, L:1750 MM

MOUNTING KIT FOR GATE WITH PIN LOCK

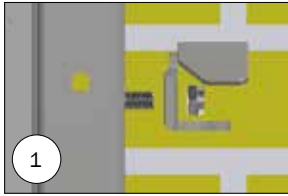

1
Mounting of bracket is bolt from post in use

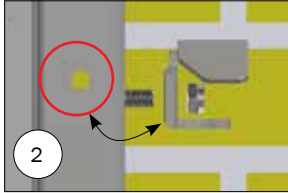

2
Mounting of bracket is bolt from post in use. Post is turned so footplates is turning out/inside.

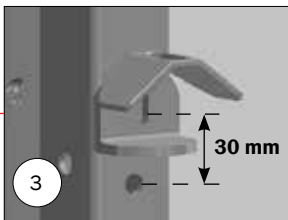

3
Mounting of drop latch "make new hole with M10 thread at the place. Must be ordered separately:
Set screw for mounting " 30310025"
SET SCREW M10X25 A2 DIN 933

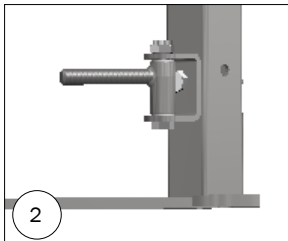

2
Distance between floor and bottom of gate is 30 mm

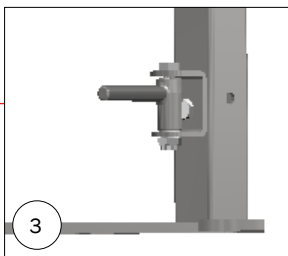

3
Distance between floor and bottom of gate is 40 mm

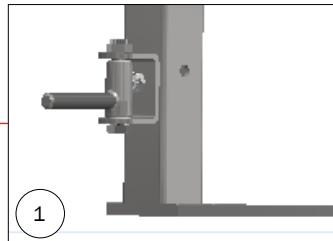

1
Distance between floor and bottom of gate is 10 mm

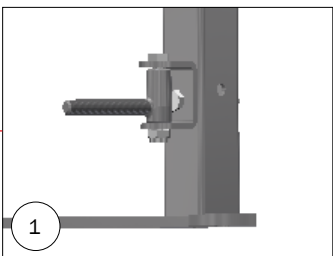

1
Distance between floor and bottom of gate is 20 mm

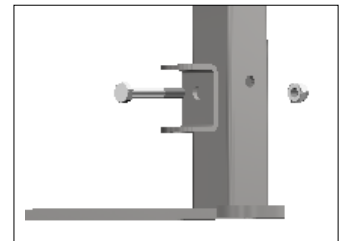

Bracket is mounted with bolt from post

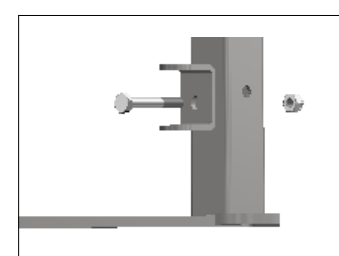

Bracket is mounted with bolt from post

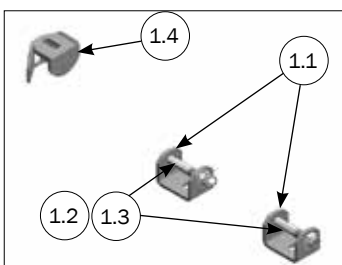

PARTS LIST			
NO.	PCS.	ITEM NO.	DESCRIPTION
1	1	4000904	KIT FOR GATE WITH PIN BOLT
1.1	2	29715HG	INN-O-FLEX HINGE BRACKET
1.2	2	67549	M12 X 80 HEX HEAD BOLT A2
1.3	2	33912000	LOCK NUT M12 A2 DIN 985
1.4	1	1915043	DROP LATCH 40 MM.

MOUNTING KIT FOR GATE WITH TWIST

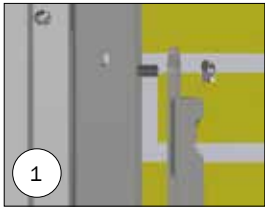

1
Mounting of bracket is bolt from post in use

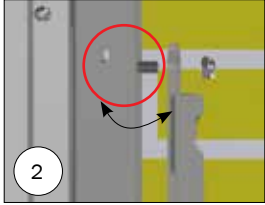

2
Mounting of bracket is bolt from post in use. Post is turned so footplates is turning out/inside.

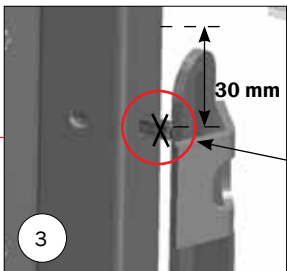

3
Mounting of receiverbracket "make new hole with M10 thread at the place".
Must be ordered separately:
Set screw for mounting " 30310025"
SET SCREW M10X25 A2 DIN 933

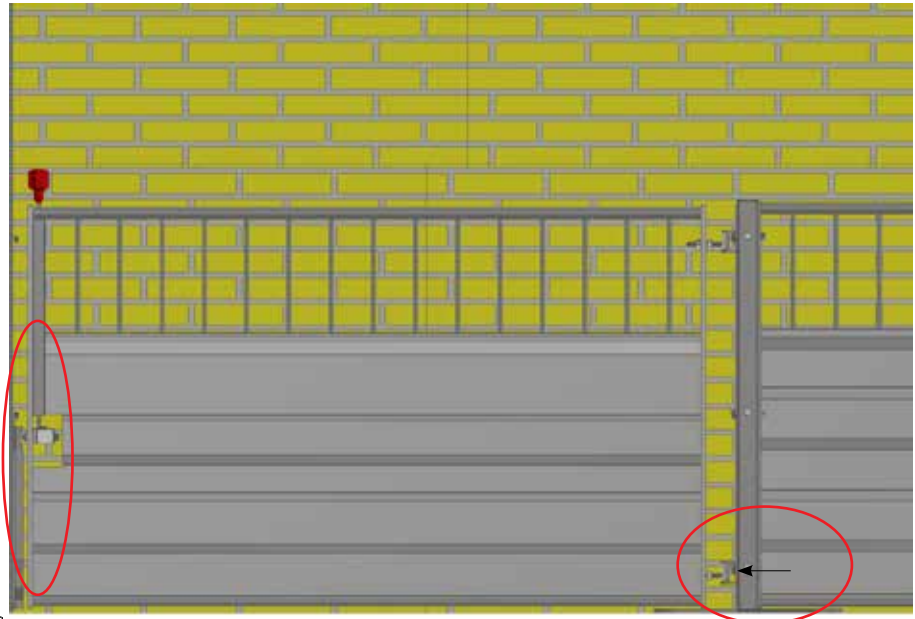

Existing bolt is cut of for mounting of bracket.

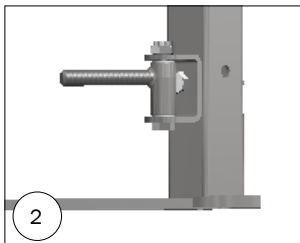

2
Distance between floor and bottom of gate is 30 mm

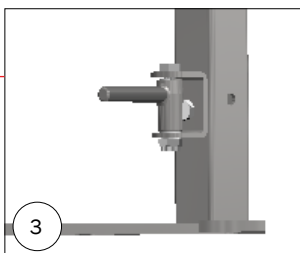

3
Distance between floor and bottom of gate is 40 mm

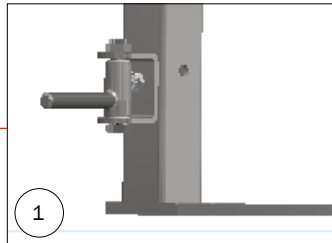

1
Distance between floor and bottom of gate is 10 mm

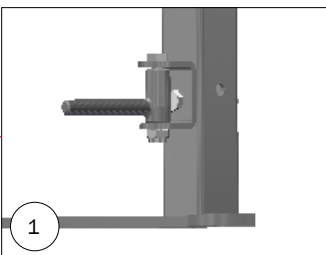

1
Distance between floor and bottom of gate is 20 mm

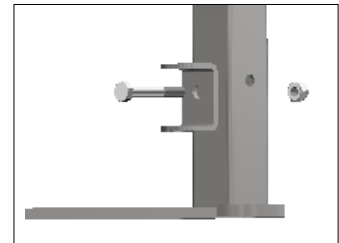

Bracket is mounted with bolt from post

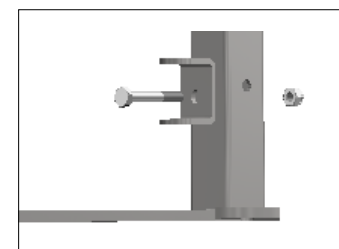

Bracket is mounted with bolt from post

PARTS LIST			
NO.	PCS.	ITEM NO.	DESCRIPTION
1	1	4000896	KIT FOR GATE WITH TWISTLOCK
1.1	2	29715HG	INN-O-FLEX HINGE BRACKET
1.2	2	67549	M12 X 80 HEX HEAD BOLT A2
1.3	2	33912000	LOCK NUT M12 A2 DIN 985
1.4	1	29728	INN-O-FLEX RECEIVERBRACKET

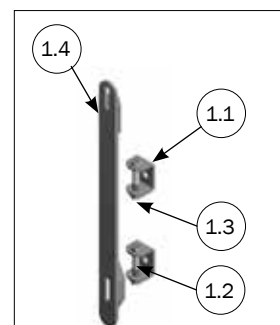

MOUNTING OF GATE AGAINST WALL

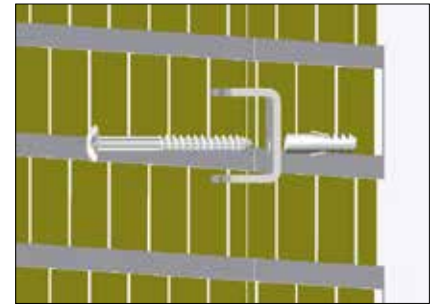
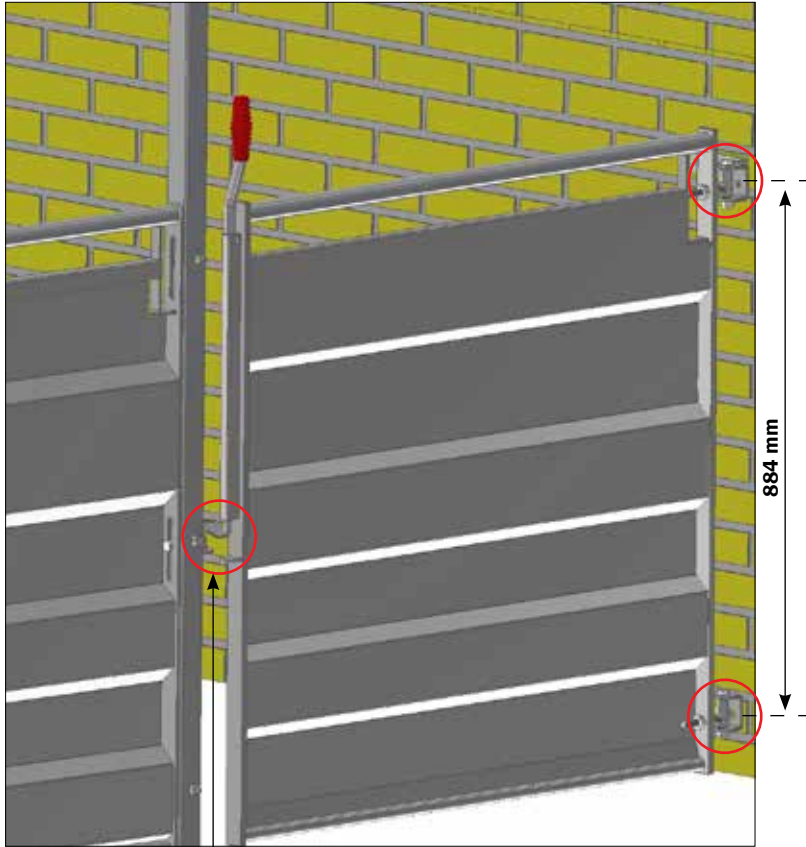

Mounting on wall "4800010"
10 PCS. SS BUTTON HEAD SCREWS 10X70
+ WALL PLUG

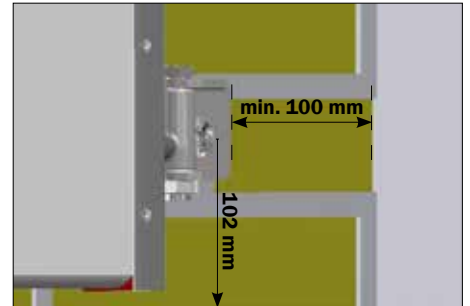

Distance from edge of wall to bracket min. 100 mm
distance from floor to hole on bracket is 102 mm

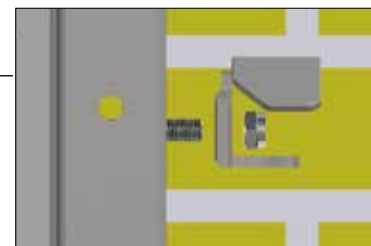

Bracket is mounted with bolt
from post.

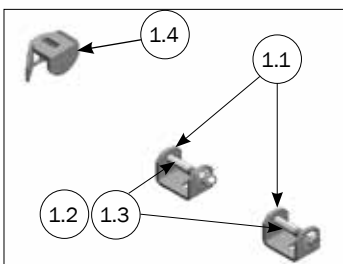
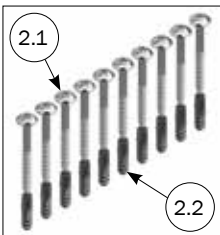

PARTS LIST

NO.	PCS.	ITEM NO.	DESCRIPTION
1	1	4000904	KIT FOR GATE WITH PIN BOLT
1.1	2	29715HG	INN-O-FLEX HINGE BRACKET
1.2	2	67549	M12 X 80 HEX HEAD BOLT A2
1.3	2	33912000	LOCK NUT M12 A2 DIN 985
1.4	1	1915043	DROP LATCH 40 MM.
2	1	4800010	10 PCS. SS BUTTON HEAD SCREWS 10X70 + WALL PLUG
2.1	(10) 2	67444	10 X 70 BUTTON HEAD TORX 50 STAINLESS STEEL
2.2	(10) 2	39900001	WALL PLUG 12X60 MM

MOUNTING OF GATE WITH TWIST AGAINST WALL

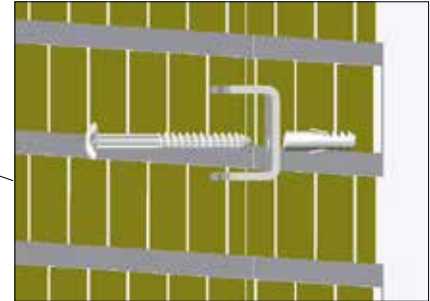
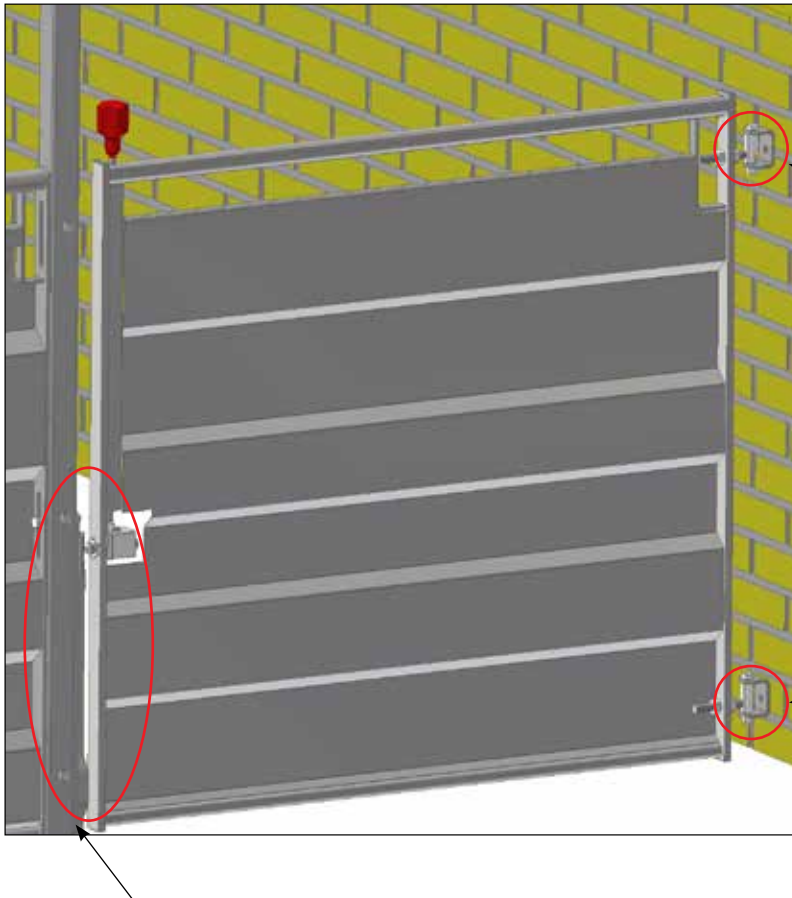

Mounting on wall "4800010"
10 PCS. SS BUTTON HEAD SCREWS 10X70
+ WALL PLUG

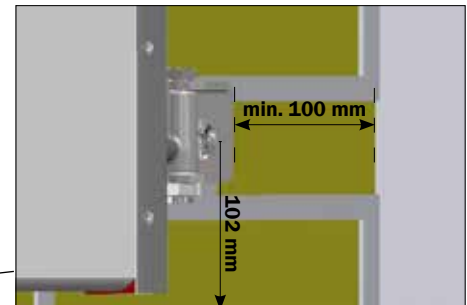

Distance from edge of wall to bracket min. 100 mm
distance from floor to hole on bracket is 102 mm

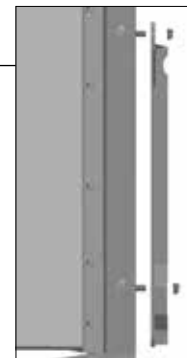

Bracket is mounted with bolt
from post.

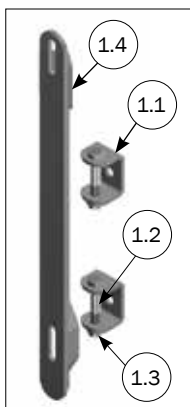
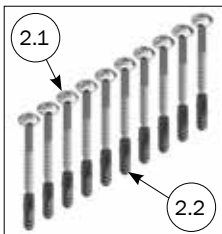

PARTS LIST

NO.	PCS.	ITEM NO.	DESCRIPTION
1	1	4000896	KIT FOR GATE WITH TWISTLOCK
1.1	2	29715HG	INN-O-FLEX HINGE BRACKET
1.2	2	67549	M12 X 80 HEX HEAD BOLT A2
1.3	2	33912000	LOCK NUT M12 A2 DIN 985
1.4	1	29728	INN-O-FLEX RECEIVERBRACKET
2	1	4800010	10 PCS. SS BUTTON HEAD SCREWS 10X70 + WALL PLUG
2.1	(10) 2	67444	10 X 70 BUTTON HEAD TORX 50 STAINLESS STEEL
2.2	(10) 2	39900001	WALL PLUG 12X60 MM

MOUNTING OF GATE ON HIGH/LOW POST

Gate **must** be mounted direct on cross

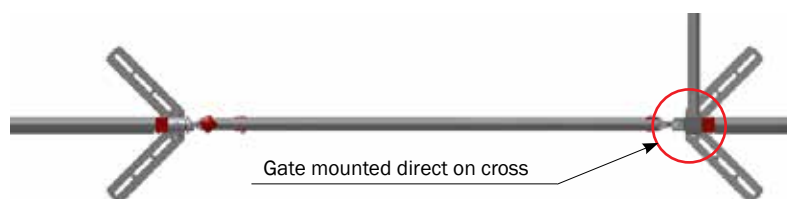
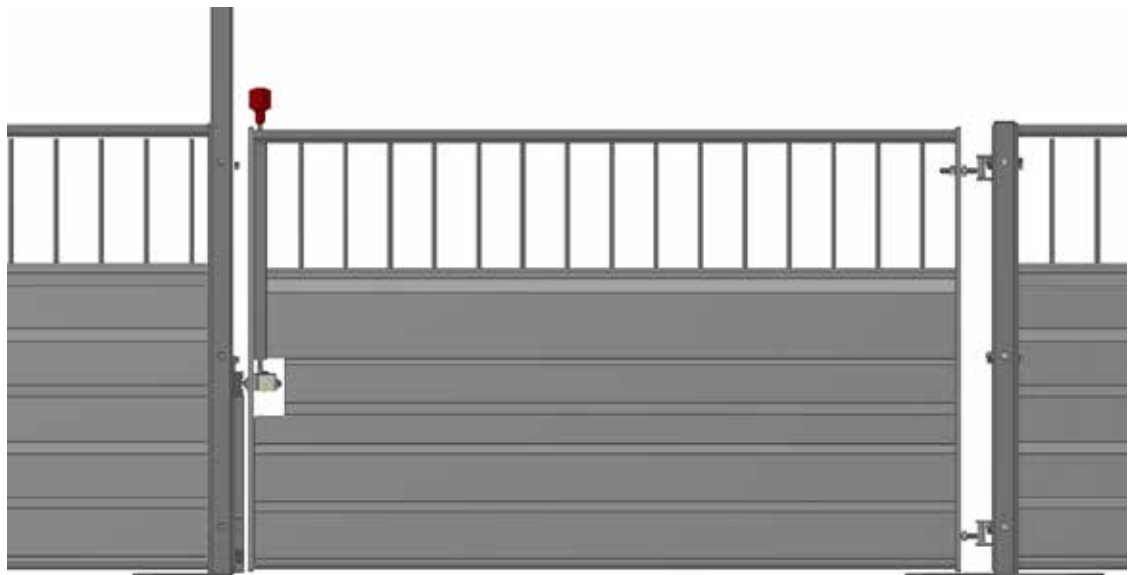
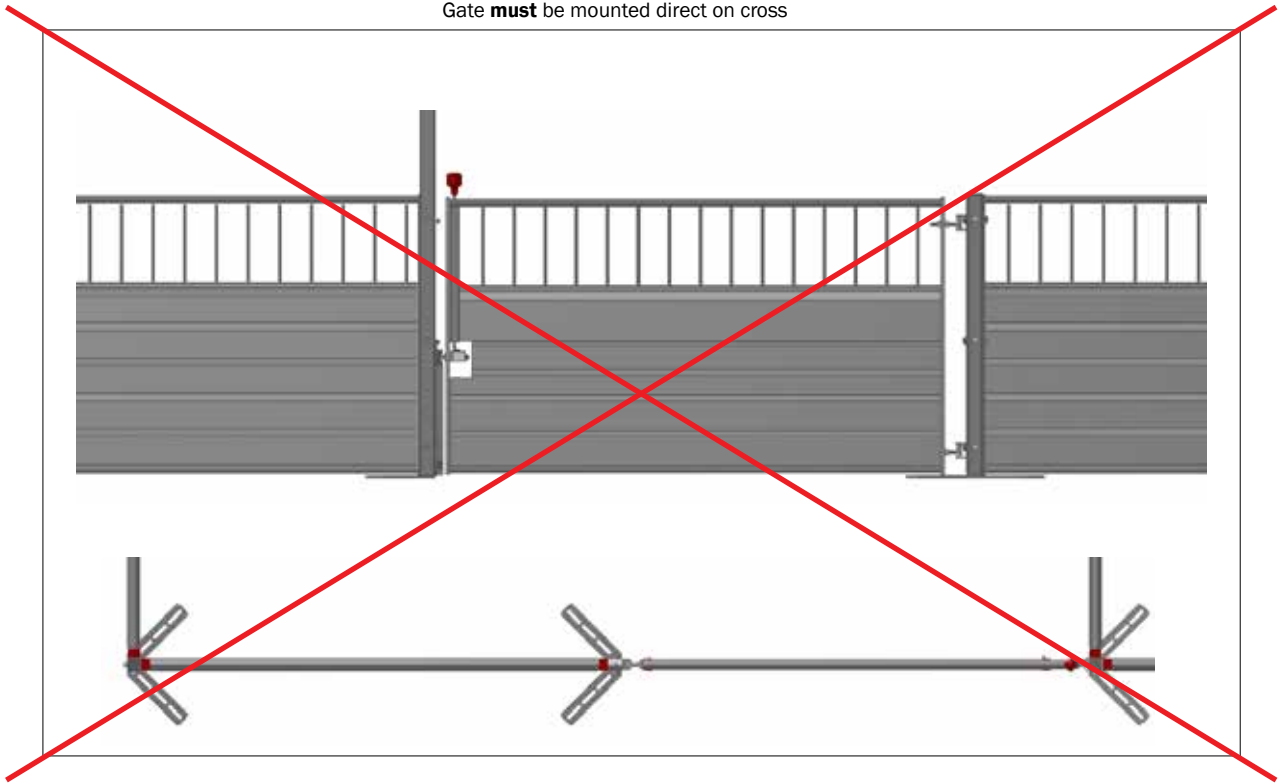

Gate mounted direct on cross

MOUNTING OF HIGH POST

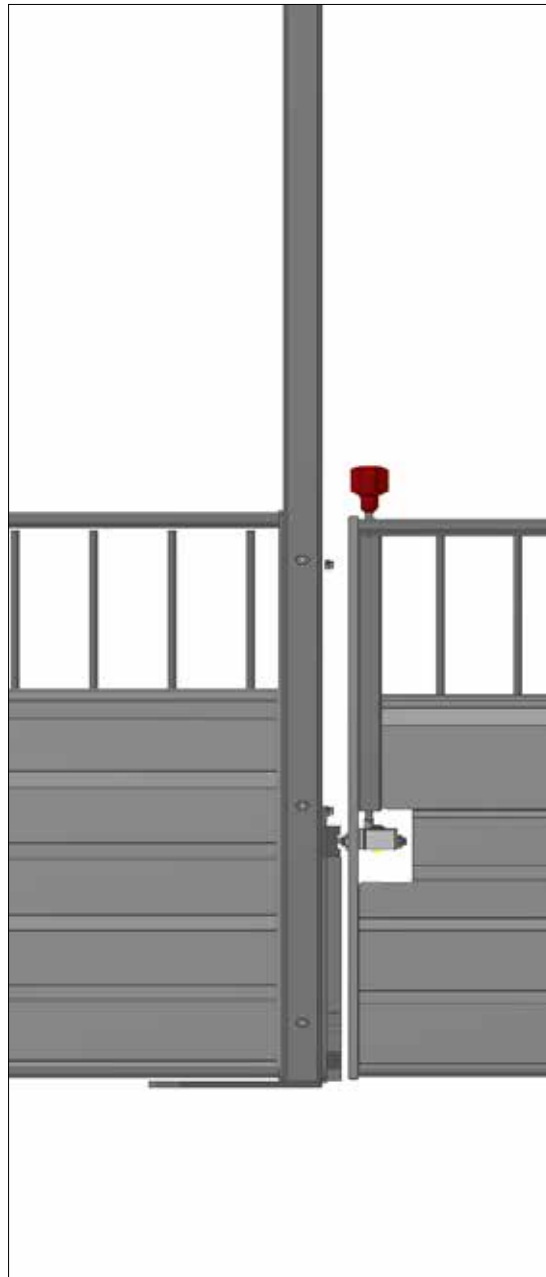
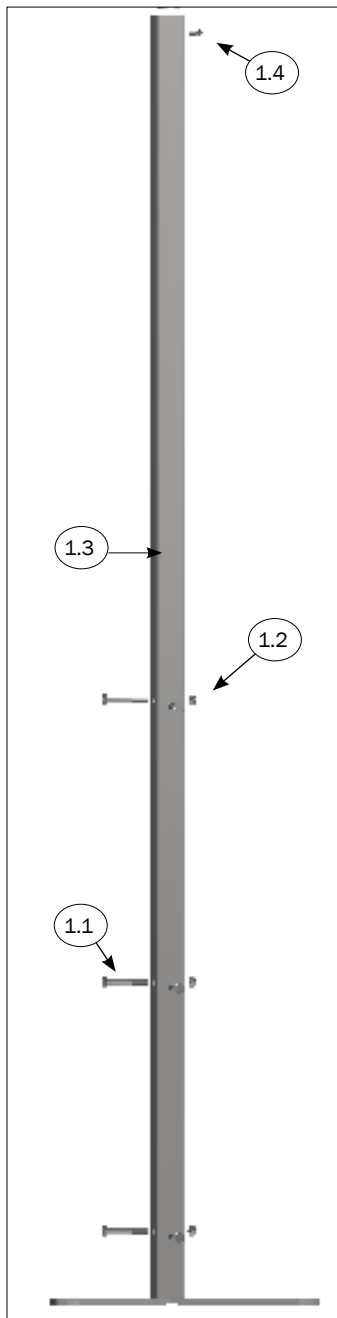
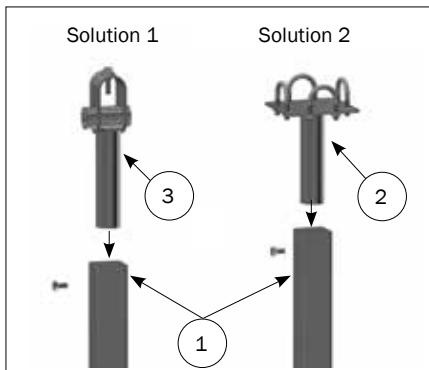

POS. 1.1 is not in use.
When mounting of post against
side “

PARTS LIST

NO.	PCS.	ITEM NO.	DESCRIPTION
1	1	4000643	HIGH POST INCL. SCREWS AND NUTS
1.1	6	32510075	MACHINE SCREW M10X70 A2 QUAL.10.9 DIN 931
1.2	6	33900029	LOCK NUT M10 A2 DIN 985
1.3	1	4020643	HIGH POST
1.4	1	30308016	SET SCREW M8X16 A2 DIN 933
2	1	1900320	CROSS CONNECTION WITH 1" U-BOLT
3	1	1900080	CROSS CONNECTION 1"X1" WITH Ø38 MM PIPE, INCL BOLT

MOUNTING OF POST AGAINST WALL

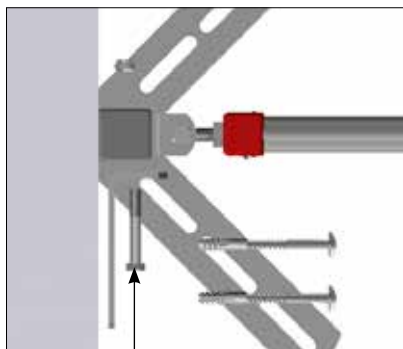
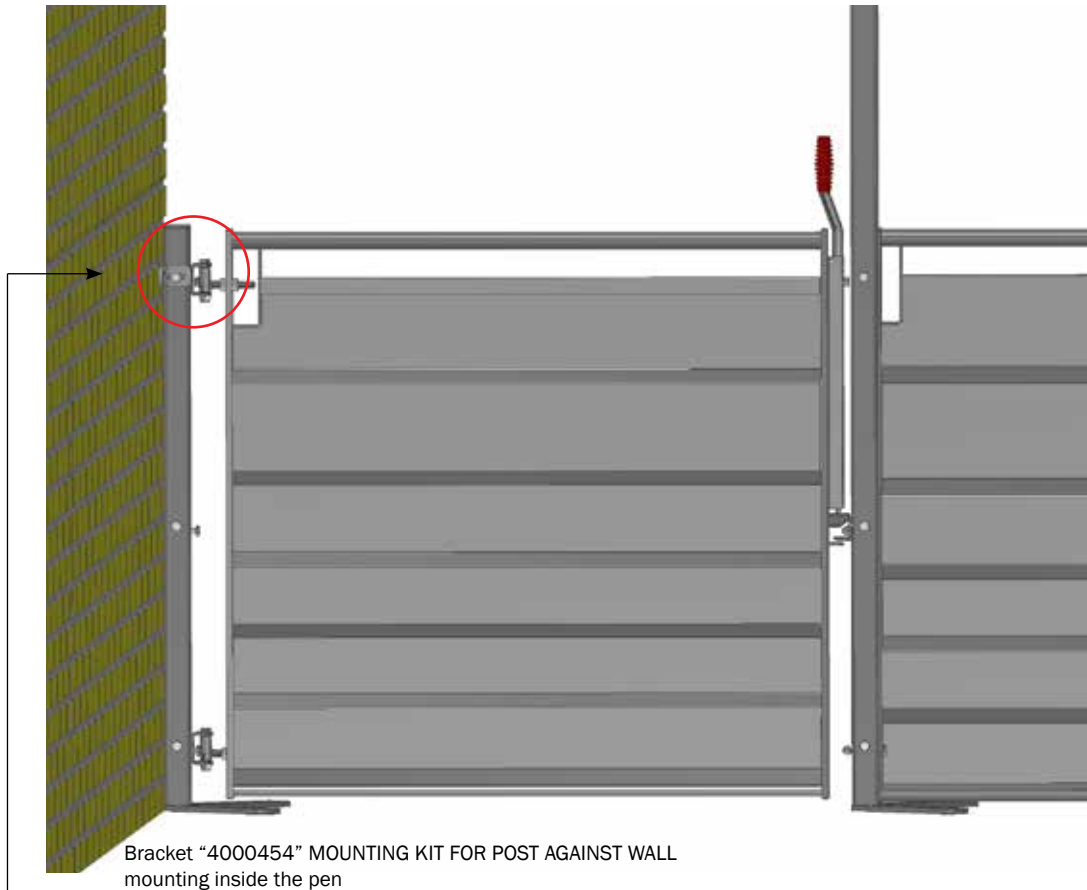

Bracket is mounted with bolt from post

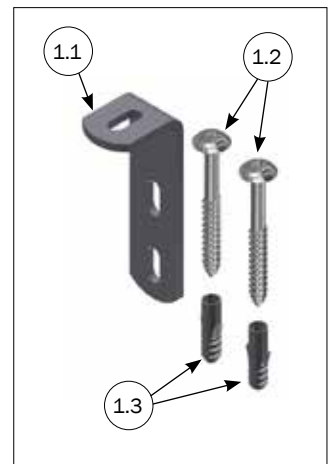

PARTS LIST			
NO.	PCS.	ITEM NO.	DESCRIPTION
1	1	4000454	MOUNTING KIT FOR POST AGAINST WALL
1.1	1	4020299	WALL FITTING FOR FRAME
1.2	2	67444	10 X 70 BUTTON HEAD TORX 50 STAINLESS STEEL
1.3	2	39900001	WALL PLUG 12X60 MM

MOUNTING OF PIPE ON HIGH POST

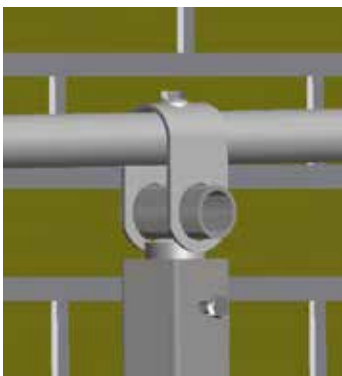
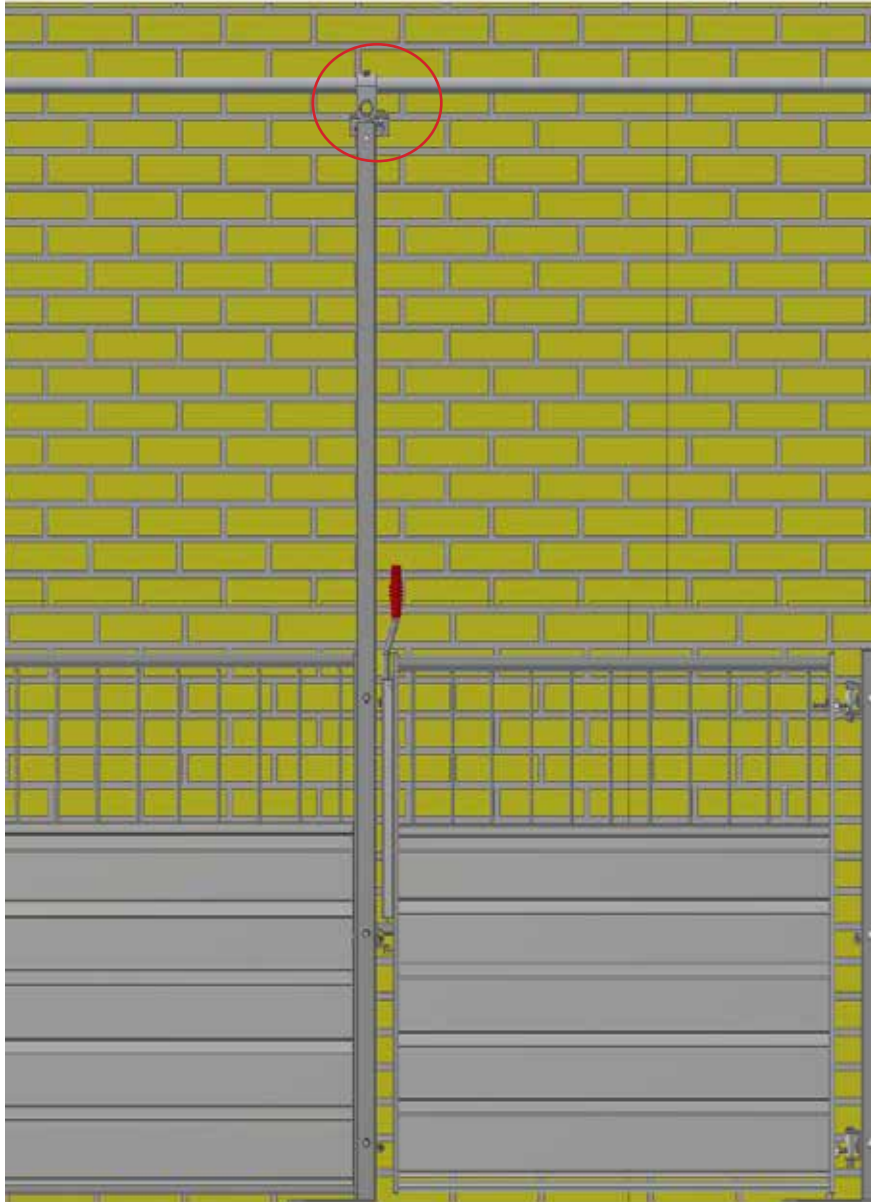

PIPE 70 MM is only in use when one pipe is mounted.

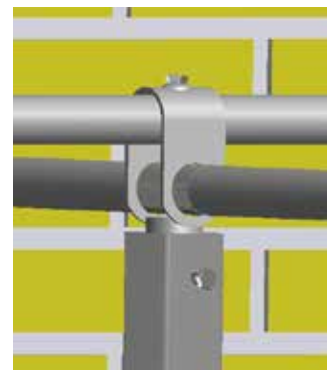

MOUNTING OF PIPE

DISTANCE BETWEEN PIPES MAX. 3.5 m

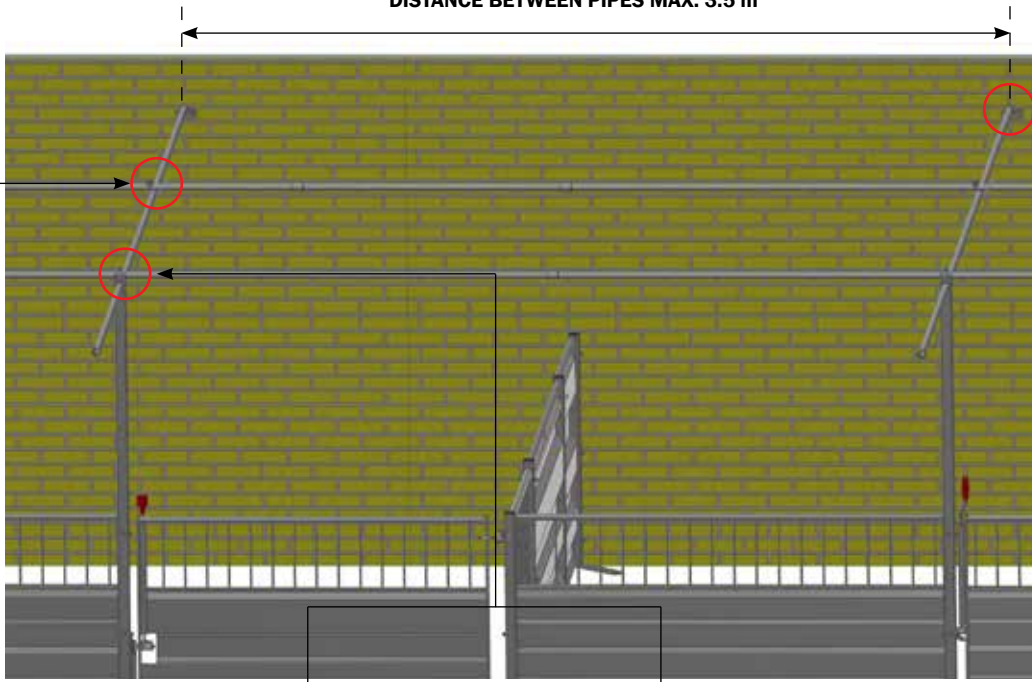

Solution 1

Solution 2

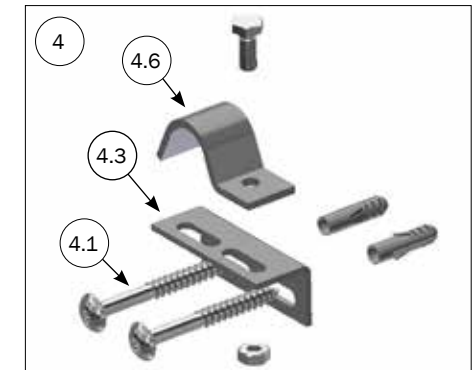
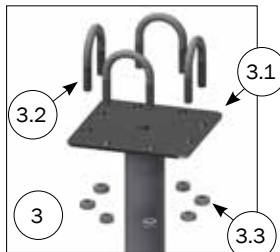
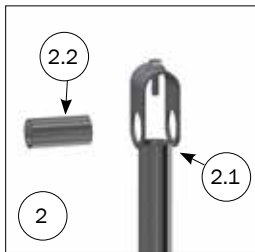
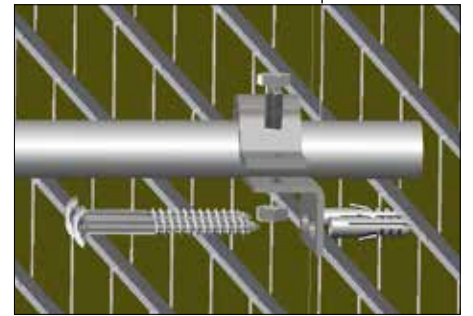
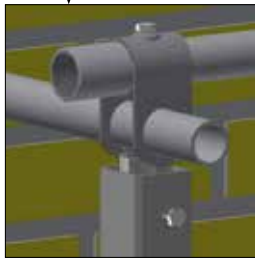

PARTS LIST

NO.	PCS.	ITEM NO.	DESCRIPTION
1	1	9930014	WINDING CLAMP 1"X1"
2	1	1900080	CROSS CONNECTION 1"X1" WITH Ø38 MM PIPE, INCL BOLT
2.1	1	1910080	DOG CLAMP WITH PIPE
2.2	1	8100240	1" GALVANIZED PIPE L=70 MM
3	1	1900320	CROSS CONNECTION WITH 1" U-BOLT
3.1	1	1920320	CROSS CONNECTION FOR 1" U-BOLT, SUPPORT
3.2	4	90100049	U-CLAMP 1" 8X50 MM GALVANIZED
3.3	8	33208014	NUT M8 HDG DIN 934
4	1	3900019	FITTING FOR WATERPIPE, COMPLETE
4.1	2	67444	10 X 70 BUTTON HEAD TORX 50 STAINLESS STEEL
4.2	2	39900001	WALL PLUG 12X60 MM
4.3	1	3920096	WALL FITTING FOR WATER PIPE
4.4	1	30310025	SET SCREW M10X25 A2 DIN 933
4.5	1	33510017	NUT M10 A2 DIN 934 WAXED
4.6	1	16375	PIPE RETAINER 1" WITHOUT BOLT

STABILIZATION OF POSTS WHERE THE PIPE REACHES THE WALL

ATTENTION! Rules are exemplified with illustrations for INN-O-FLEX 35mm. The same rules apply to INN-O-FLEX STEEL

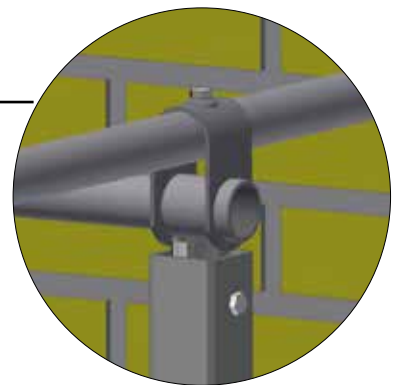
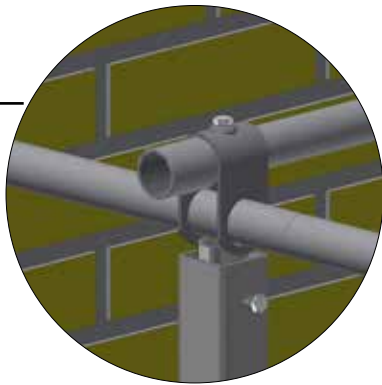
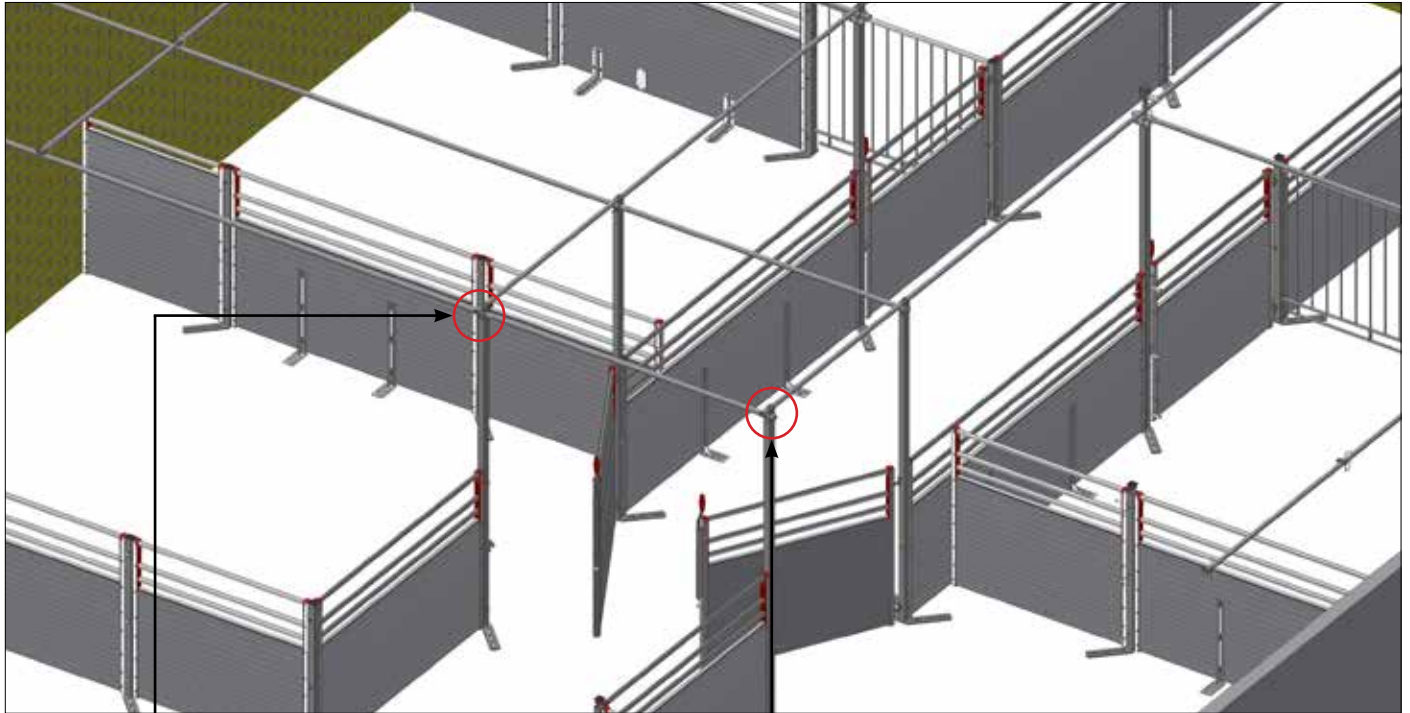

Direction of the post's footplate in relation to best stabilization

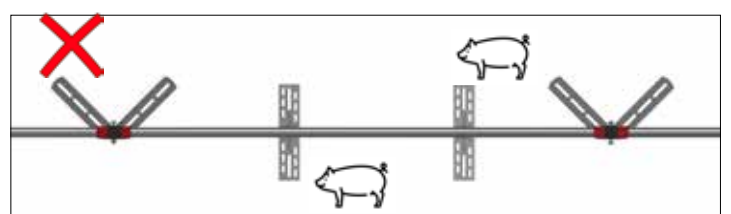
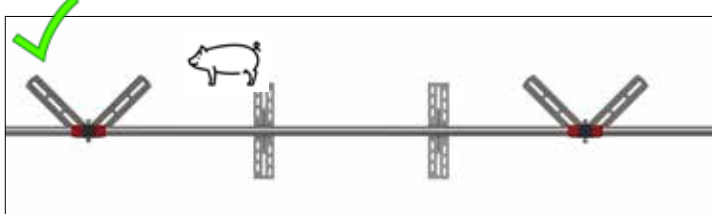
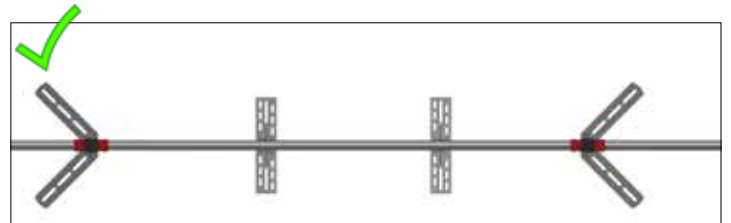
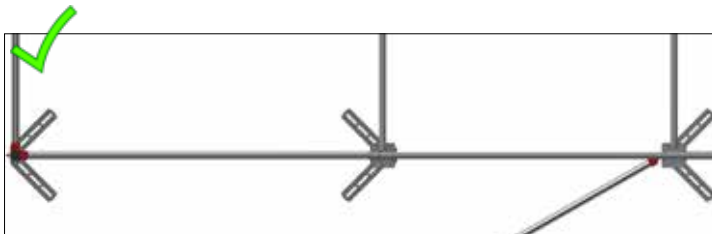

STABILIZING POSTS WHERE THE PIPE CANNOT REACH THE WALL

ATTENTION! Rules are exemplified with illustrations for INN-O-FLEX 35mm. The same rules apply to INN-O-FLEX STEEL

